

VEX1000 Wiring diagram

EXcon+ automatic

EXcon+ automatik

Systeme de régulation EXcon+

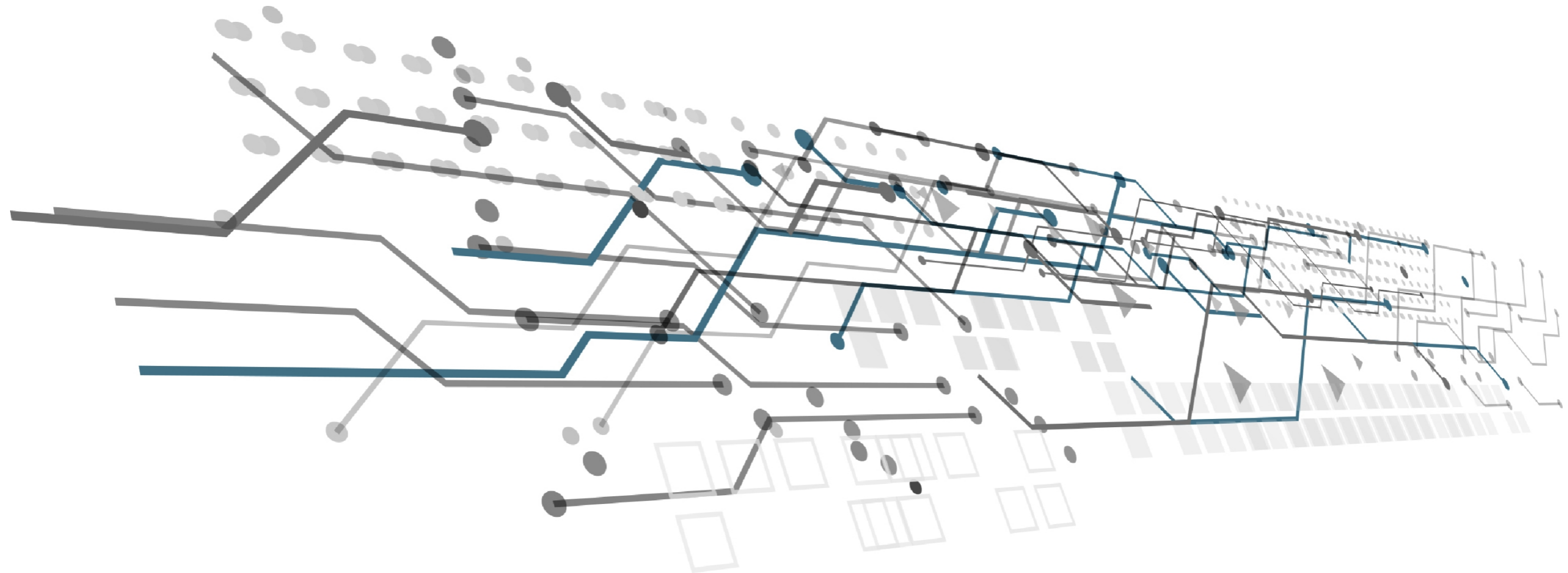

VEX1000 - Control panel (1x230V)

2028124

Manufactured by: EXHAUSTO	Project: VEX1000 - Control panel (1x230V)	Start date: 01-06-2023	Constructor: DKTSA	Page: 1
		Revision date: 12-05-2026	Approved by: DKBP	Previous page: 0
Drawing number: 2028124	Page Title: Project information	Revision: E	Scale: 1:1	Next page: 2
		Replaces revision: D	Format: A3	Pages in total: 40

Page	Title	(GB)	Titel	(DE)	Titre	(FR)	Last edit
1	Project information		Projektinformationen		Informations sur le projet		13-03-2026
3	Standards		Standard		Normes		06-03-2026
4	Standards		Standard		Normes		06-03-2026
5	Component overview		Komponentenübersicht		Vue d'ensemble des composants		12-05-2026
9	Principles for all configuration options		Prinzipien für alle Konfigurationsoptionen		Principes pour toutes les options de configuration		21-05-2025
10	Control panel layout		Layout des Schaltschrank		Disposition du tableau de commande		17-03-2026
11	Control panel terminals		Klemmen des Schaltschranks		Bornes du tableau de commande		17-03-2026
20	Main current		Hauptstrom		Courant principal		12-05-2026
21	Pilot current		Steuerstrom		Courant pilote		12-05-2026
22	Standard - Modbus connections		Standard – Modbus-Anschlüsse		Standard – Raccordements pour modbus		12-05-2026
23	Standard - Fan & Rotor/Bypass controls		Standard – Ventilator- und Rotor-/Bypass-Steuerungen		Standard – Commandes by-pass / du ventilateur et du rotor		12-05-2026
24	Standard - Dampers		Standard – Register		Standard - Volets		12-05-2026
25	Options - Dampers		Optionen – Register		Options - Volets		12-05-2026
26	Options - Pre-heating controls		Optionen – Vorheizregler		Options – Commandes de préchauffage		12-05-2026
27	Options - Post-heating controls		Optionen – Nachheizregler		Options – Commandes de post-chauffage		12-05-2026
28	Options - HW/CW/CO controls		Optionen – HW/CW/CO-Regler		Options – Commandes HW/CW/CO		12-05-2026
29	Options - Temperature & CO2 sensors		Optionen – Temperatur- und CO2-Sensoren		Options – Capteurs de température et de CO2		12-05-2026
30	Standard - Customer connections		Standard – Kundenseitige Anschlüsse		Standard – Raccordements du client		12-05-2026
40	Standard - Dual PTH 1		Standard – Doppel-PTH 1		Standard – Double PTH 1		12-05-2026
41	Standard - Dual PTH 2		Standard – Doppel-PTH 2		Standard – Double PTH 2		12-05-2026
42	Option - ALC™ - Rotor deicing - HR temperature		Option - ALC™ - Rotorenteisung - WRG-Temperatur		Option - ALC™ - Dégivrage du rotor - Température RC		12-05-2026
43	Option - Counter-flow deicing - HR temperature		Option - Gegenstrom-Abtauung - WRG-Temperatur		Option - Dégivrage à contre-courant - Température RC		12-05-2026
50	Option – Coil control box layout		Option – Layout des Spulensteuerkastens		Option – Disposition du boîtier de commande du serpentin		12-05-2026
51	Option - Combi Coil (CO)		Option – Kombiregister (CO)		Option - Serpentin mixte (CO)		12-05-2026
52	Option - Direct Expansion Heat pump (DX)		Option – Heizregister für Direkte Expansion (DX)		Option - Batterie de chauffage à détente directe (DX)		12-05-2026
53	Option - Direct Expansion Cooling (DX)		Option – Kühlregister für Direkte Expansion (DX)		Option - Batterie de refroidissement à détente directe (DX)		12-05-2026
60	Option – Kitchen Solution Box ventilator		Option – Küchenlüftung Boxventilatoren		Option – Caisson d'extraction pour application cuisine		12-05-2026
61	Option - Kitchen Solution Air speed regulator		Option – Küchenlüftung Luftgeschwindigkeitsregler		Option – Régulateur de vitesse d'air pour application cuisine		12-05-2026

Manufactured by: EXHAUSTO	Project: VEX1000 - Control panel (1x230V)	Start date: 01-06-2023	Constructor: DKTSA	Page: 2
Drawing number: 2028124	Page Title: Table of Contents	Revision date: 12-05-2026	Approved by: DKBP	Previous page: 1
		Revision: E	Scale: 1:1	Next page: 3
		Replaces revision: D	Format: A3	Pages in total: 40

Identification of wires by colour (according to EN 60204-1)

<u>Main current:</u>	<u>Hauptstrom:</u>	<u>Courant principal:</u>	<u>400/230VAC</u>
Phase:	Phase:	Phase :	BK
Neutral:	Neutral:	Neutre :	BK
Earth:	Erde:	Terre :	GNYE
<u>Pilot current:</u>	<u>Steuerstrom:</u>	<u>Courant pilote:</u>	<u>230/24VAC</u>
Phase:	Phase:	Phase :	RD
Neutral:	Neutral:	Neutre :	RD
Earth:	Erde:	Terre :	GNYE
<u>Pilot current:</u>	<u>Steuerstrom:</u>	<u>Courant pilote:</u>	<u>24VDC</u>
<u>Positive (+):</u>	<u>Positiv (+):</u>	<u>Positif (+) :</u>	<u>BU</u>
<u>Negative (-):</u>	<u>Negativ (-):</u>	<u>Négatif (-) :</u>	<u>BU</u>
<u>Unknown potential:</u>	<u>Unbekanntes Potenzial:</u>	<u>Potentiel inconnu:</u>	
All:	Alle:	Tout:	OG

Abbreviations of colours (according to IEC 60757)

Black	Schwarz	Noir	BK
Brown	Braun	Marron	BN
Red	Rot	Rouge	RD
Orange	Orange	Orange	OG
Yellow	Gelb	Jaune	YE
Green	Grün	Vert	GN
Blue	Blau	Bleu	BU
Light Blue	Hellblau	Bleu clair	BU
Violet	Violett	Violet	VT
Gray	Grau	Gris	GY
White	Weiß	Blanc	WH
Pink	Rosa	Rose	PK
Green/Yellow	Grün/Gelb	Vert/Jaune	GNYE
Light-	Hell-	-clair	LT-

Labelling of cables and cores (according to IEC 62491)

Method CL

Method	Description
0	No labelling
A	Use of designated cables or cores
R	Identification labelling by means of reference designation (including cable number)
CL	Local-end connection labelling
CR	Remote-end connection labelling
CB	Both-end connection labelling
S	Signal labelling

Methode	Beschreibung
0	Keine Kennzeichnung
A	Verwendung vorgesehener Kabel oder Adern
R	Identifikationskennzeichnung mittels Referenzbezeichnung (inkl. Kabelnummer)
CL	Kennzeichnung der lokalen Verbindung
CR	Kennzeichnung der Remote-End-Verbindung
CB	Beidseitige Anschlussbeschriftung
S	Signalbeschriftung

Méthode	Description
0	Pas d'étiquetage
A	Utilisation de câbles ou per fil dédiés
R	Marquage d'identification au moyen d'une désignation de référence
CL	Étiquetage des connexions locales
CR	Étiquetage des connexions distantes
CB	Étiquetage des connexions aux deux extrémités
S	Étiquetage des signaux

Manufactured by: EXHAUSTO	Project: VEX1000 - Control panel (1x230V)	Start date: 01-06-2023	Constructor: DKTSA	Page: 3
Drawing number: 2028124	Page Title: Standards	Revision date: 12-05-2026	Approved by: DKBP	Previous page: 2
		Revision: E	Scale: 1:1	Next page: 4
		Replaces revision: D	Format: A3	Pages in total: 40

Component	Location (GB)	Standort (DE)	Emplacement (FR)
+A0	Customer connections	Kundenanschlüsse	Raccordements du client
+A1	Control Panel	Schaltschrank	Tableau de commande
+A2	Cable connections to AHU aggregate	Kabelverbindungen zum RLT-Lüftungsgerät	Raccordements de câbles à l'appareil CTA
+A3	AHU aggregate	RLT-Lüftungsgerät	Appareil CTA
+A4	Outside AHU aggregate	Außenseite des RLT-Lüftungsgeräts	À l'extérieur de l'appareil CTA

Component	Object	Examples	Objekt	Beispiele	Objet	Exemples
-B	Sensing	CO2 & temperature sensors	Sensorik	CO2- und Temperatursensoren	Détection	Sondes de CO2 et de température
-C	Storage	USB drives & application keys	Speicher	USB-Sticks und Anwendungsschlüssel	Stockage	Clés USB et clés d'application
-E	Emitting	Electric heaters	Emission	Elektrische Heizgeräte	Émetteur	Chauffages électriques
-F	Protecting	Miniature circuit-breaker	Schutz	Miniaturlistungsschalter	Protection	Disjoncteur à maximum miniature
-G	Generating	Circulation pumps	Erzeugung	Umwälzpumpen	Générateur	Pompes de circulation
-K	Information processing	AHU Controller	Informationsverarbeitung	RLT-Lüftungsgerätesteuerung	Traitement de l'information	Cerveau de l'appareil CTA
-M	Driving	Motors	Antrieb	Motoren	Entrainement	Moteurs
-Q	Controlling	Supply disconnecting device	Steuerung	Versorgungstrennvorrichtung	Commande	Dispositif de déconnexion de l'alimentation
-R	Restricting	Valves & dampers	Drosselung	Ventile und Register	Limitation	Vannes et volets
-S	Human interaction	Touch panel	Menschliche Interaktion	Bedienfeld mit Touchscreen	Interaction humaine	Écran tactile
-T	Transforming	Power supply	Transformation	Stromversorgung	Transformation	Alimentation électrique
-U	Holding	Cabinet, wire-duct & DIN-rails	Halten	Schrank, Kabelkanal und DIN-Schienen	Maintien	Cabinet de ventilateur, gaine de câbles et rails DIN
-W	Guiding	Cables, wires & tubes	Führung	Kabel, Drähte und Rohre	Guidage	Câbles, fils & tubes
-X	Interfacing	Terminals & plugs	Schnittstellen	Klemmen und Stecker	Interface	Terminaux & bornes

(=)	Function	Funktion	Fonction
(+)	Location	Standort	Lieu
(-)	Product	Produkt	Produit
(.)	Sub name	Unterbezeichnung	Sous-titre

Principles of structures and reference designations according to ISO/IEC RDS 81346
Grundlagen von Strukturen und Referenzbezeichnungen gemäß ISO/IEC RDS 81346
Principes de structures et désignations de référence selon ISO/IEC RDS 81346

Manufactured by: EXHAUSTO	Project: VEX1000 - Control panel (1x230V)	Start date: 01-06-2023	Constructor: DK TSA	Page: 4
		Revision date: 12-05-2026	Approved by: DKBP	Previous page: 3
Drawing number: 2028124	Page Title: Standards	Revision: E	Scale: 1:1	Next page: 5
		Replaces revision: D	Format: A3	Pages in total: 40

Component	Function	(GB)	Funktion	(DE)	Fonction	(FR)
-0V	Terminals for 0VDC		Anschlüsse für 0 V DC		Bornes pour 0VDC	
-24V	Terminals for 24VDC		Anschlüsse für 24 V DC		Bornes pour 24VDC	
-B1.1	Extract air temperature		Außenlufttemperatur		Température de l'air extrait	
-B1.2	Exhaust air temperature		Fortlufttemperatur		Température de l'air rejeté	
-B2.1	Outdoor air temperature		Außenlufttemperatur		Température de l'air extérieur	
-B2.2	Supply airflow temperature correction		Zulufttemperatur-Korrektur		Correction de la température de l'air soufflé	
-B3	Heating return water temperature sensor		Temperatursensor Heizungsrücklaufwasser		Sonde de température de l'eau de retour (chauffage)	
-B4	CO/CW return water temperature sensor		CO/CW-Rücklauf-Temperatursensor		Capteur de température de retour eau chaude / eau froide	
-B5	Outdoor air temperature sensor (Pre-heater)		Außenluft-Temperatursensor (Vorwärmgerät)		Capteur de température de l'air extérieur (pré-chauffage)	
-B6	CO2 sensor		CO2-Sensor		Capteur CO2	
-B7	Duct temperature sensor		Kanaltemperatursensor		Capteur de température de conduit	
-B8	CO supply water temperature sensor		CO-Vorlauf-Temperatursensor		Capteur thermique d'alimentation en CO	
-B9	Heat recovery temperature		Wärmerückgewinnungstemperatur		Température de récupération de chaleur	
-BP1	DualPTH 1		Doppel-PTH 1		Double PTH 1	
-BP2	DualPTH 2		Doppel-PTH 2		Double PTH 2	
-BP3	DualPTH 3		Doppel-PTH 3		Double PTH 3	
-BP4	PTH for Kitchen solution		PTH für Küchenlösungen		PTH pour solution de cuisine	
-E1	Cabinet heater		Schaltschrankheizung		Chauffage de l'armoire	
-E2	Change over coils		Change-Over-Register		Serpentin de commutation	
-E3	Electric pre-heating		Elektrisches Vorheizen		Préchauffage électrique	
-E4	Electric post-heating		Elektrisches Nachheizen		Post-chauffage électrique	
-F1	MCB for Exhaust air fan		Miniaturleistungsschalter für Fortluftventilator		MCB pour ventilateur de rejet extérieur	
-F2	MCB for Supply air fan		Miniaturleistungsschalter für Zuluftventilator		MCB pour ventilateur d'air soufflé	
-F3	MCB for Rotor/Control systems		Miniaturleistungsschalter für Rotor-/Reglersysteme		MCB pour rotor/systèmes de régulation	
-F4	MCB for Circulation pumps		Miniaturleistungsschalter für Umwälzpumpe		MCB pour pompe de circulation	
-G1	Heating circulation pump		Heizungsumwälzpumpe		Pompe de circulation du chauffage	
-G2	CW/CO/DX circulation pump		CW/CO/DX-Umwälzpumpe		Pompe de circulation CW/CO/DX	
-K1	AHU Controller		Regler für RLT		Contrôleur CTA	
-K2	EXT module for Change over		EXT-Modul für Change-Over		Module EXT pour inversion	

Manufactured by: EXHAUSTO	Project: VEX1000 - Control panel (1x230V)	Start date: 01-06-2023	Constructor: DKTSA	Page: 5
Drawing number: 2028124	Page Title: Component overview	Revision date: 12-05-2026	Approved by: DKBP	Previous page: 4
		Revision: E	Scale: 1:1	Next page: 6
		Replaces revision: D	Format: A3	Pages in total: 40

Component	Function	(GB)	Funktion	(DE)	Fonction	(FR)
-M1.2	Exhaust air fan		Fortluftventilator		Ventilateur d'évacuation de l'air	
-M2.2	Supply air fan		Zuluftventilator		Ventilateur d'air soufflé	
-M3	Rotor		Rotor		Rotor	
-M4	Exhaust air fan - Box ventilator		Fortluftventilator - Boxventilator		Ventilateur d'extraction - Ventilateur de caisson	
-Q1	Supply disconnecting device		Versorgungstrennvorrichtung		Dispositif de coupure de l'alimentation	
-Q2	Supply disconnecting device for Box ventilator		Versorgungstrenneinrichtung für Boxventilator		Dispositif de coupure de l'alimentation pour ventilateur de caisson	
-R1.1	Extract air damper (ALC™)		Abluftregister (ALC™)		Registre d'air extrait (ALC™)	
-R1.2	Exhaust air damper		Fortluftregister		Registre d'air rejeté	
-R2.1	Outdoor air damper		Außenluftregister		Registre d'air extérieur	
-R2.2	Supply air damper		Zuluftregister		Registre d'air soufflé	
-R3	Bypass damper		Bypassregister		Registre de dérivation	
-R4	Mixing air damper		Mischluftregister		Registre d'air de recirculation	
-R5	Valve HW		Ventil HW		Vanne HW	
-R6	Valve CW		Ventil CW		Vanne CW	
-R7	Valve CO/DX		Ventil CO/DX		Vanne CO/DX	
-S1	Touch panel		Bedienfeld mit Touchscreen		Écran tactile	
-S2	CO system alarm		CO-Systemalarm		Système d'alarme CO	
-S3	DX control Heat pump		DX-Steuerung Wärmepumpe		Pompe à chaleur à régulation DX	
-S4	Air speed regulator		Luftstromregler		Régulateur de débit d'air	
-T1	Power supply 230VAC/24VDC		Stromversorgung 230 V AC/24 V DC		Alimentation 230 V CA/24 V CC	
-T2	DV controls for Box ventilator		DV-Regelung für Boxventilatoren		Régulation DV pour ventilateurs de caisson	
-U1	Automation board		Automatisierungsplatine		Carte d'automatisation	
-X1.1	Aggregate power terminals		Klemmen für Gerätestrom		Bornes de puissance agrégées	
-X1.2	Aggregate signal terminals		Klemmen für Gerätesignal		Bornes de signal agrégées	
-X1.3	Modbus splitter 9 x Molex		Modbus-Splitter 9 x Molex		Répartiteur Modbus 9 x Molex	
-X1	Aggregate power & signal terminals		Klemmen für Gerätestrom und -signal		Bornes d'alimentation et de signal agrégées	
-X2	Air dampers terminals		Klemmen für Luftklappen		Bornes des volets d'air	
-X3	Pre-HE signal terminals		Vor-HE-Signalklemmen		Bornes de signal de pré-CH	
-X5	HW - Power & signal terminals		HW – Strom- und Signalklemmen		HW – Bornes d'alimentation et de signal	

Manufactured by: EXHAUSTO	Project: VEX1000 - Control panel (1x230V)	Start date: 01-06-2023	Constructor: DKTSA	Page: 6
		Revision date: 12-05-2026	Approved by: DKBP	Previous page: 5
Drawing number: 2028124	Page Title: Component overview	Revision: E	Scale: 1:1	Next page: 7
		Replaces revision: D	Format: A3	Pages in total: 40

Principles

Manufactured by: EXHAUSTO	Project: VEX1000 - Control panel (1x230V)	Start date: 01-06-2023	Constructor: DKTSA	Page: Principles
		Revision date: 12-05-2026	Approved by: DKBP	Previous page: 7
Drawing number: 2028124	Page Title: Principles	Revision: E	Scale: 1:1	Next page: 9
		Replaces revision: D	Format: A3	Pages in total: 40

Arrangement drawings

Manufactured by: EXHAUSTO	Project: VEX1000 - Control panel (1x230V)	Start date: 01-06-2023	Constructor: DKTSA	Page: Arrangement
		Revision date: 12-05-2026	Approved by: DKBP	Previous page: 9
Drawing number: 2028124	Page Title: Arrangement drawings	Revision: E	Scale: 1:1	Next page: 10
		Replaces revision: D	Format: A3	Pages in total: 40

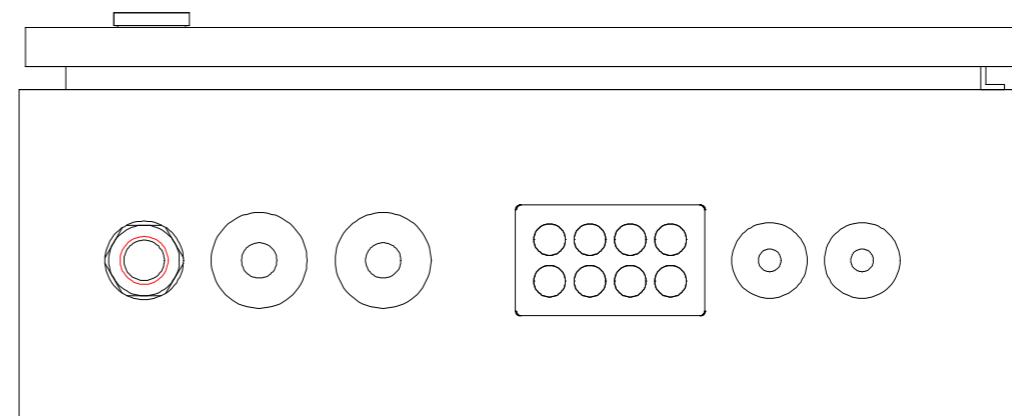
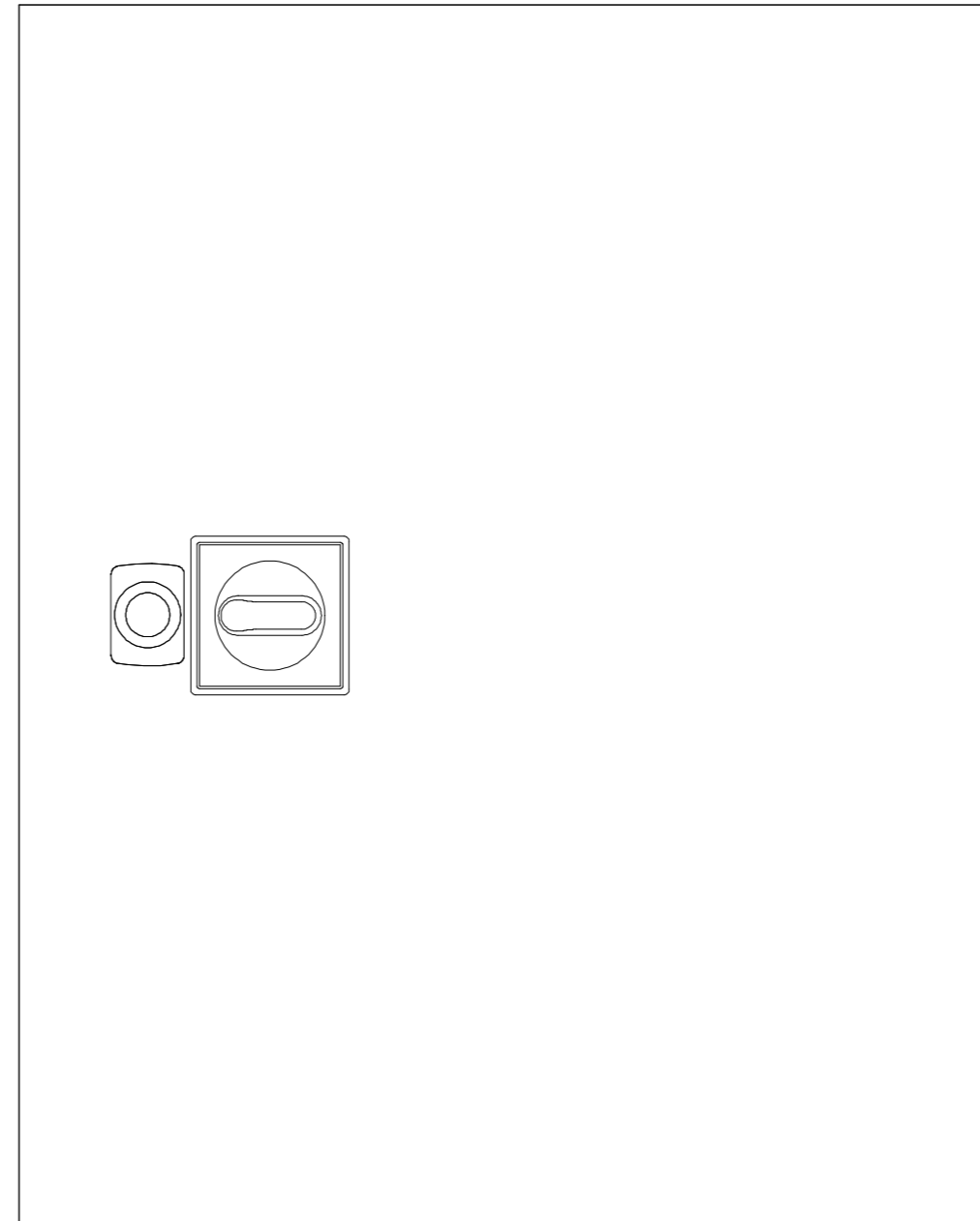
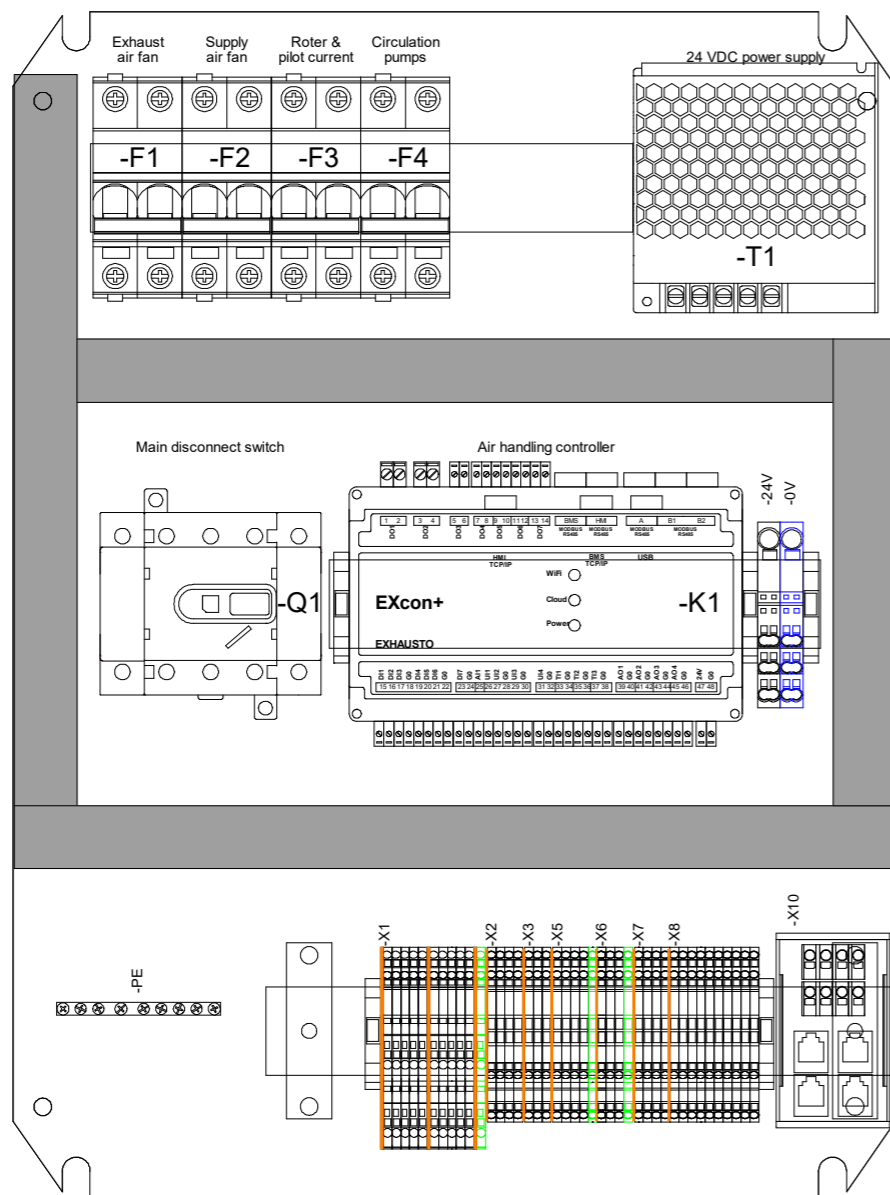

Manufactured by: EXHAUSTO	Project: VEX1000 - Control panel (1x230V)	Start date: 01-06-2023	Constructor: DKTSA	Page: 10
		Revision date: 12-05-2026	Approved by: DKBP	Previous page: 9
Drawing number: 2028124	Page Title: Control panel layout	Revision: E	Scale: 1:3	Next page: 11
		Replaces revision: D	Format: A3	Pages in total: 40

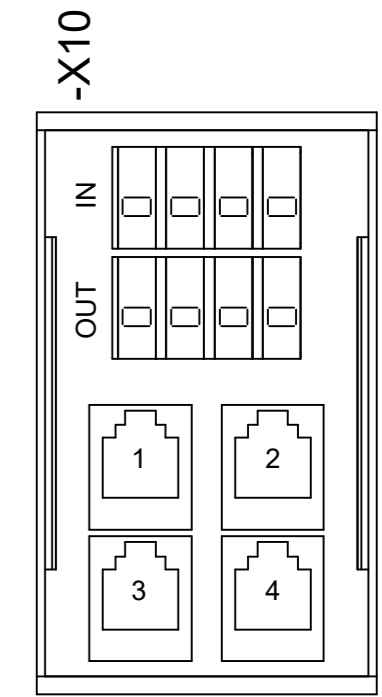
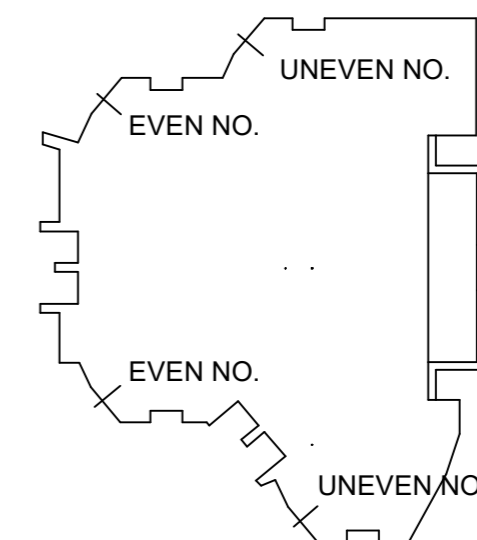
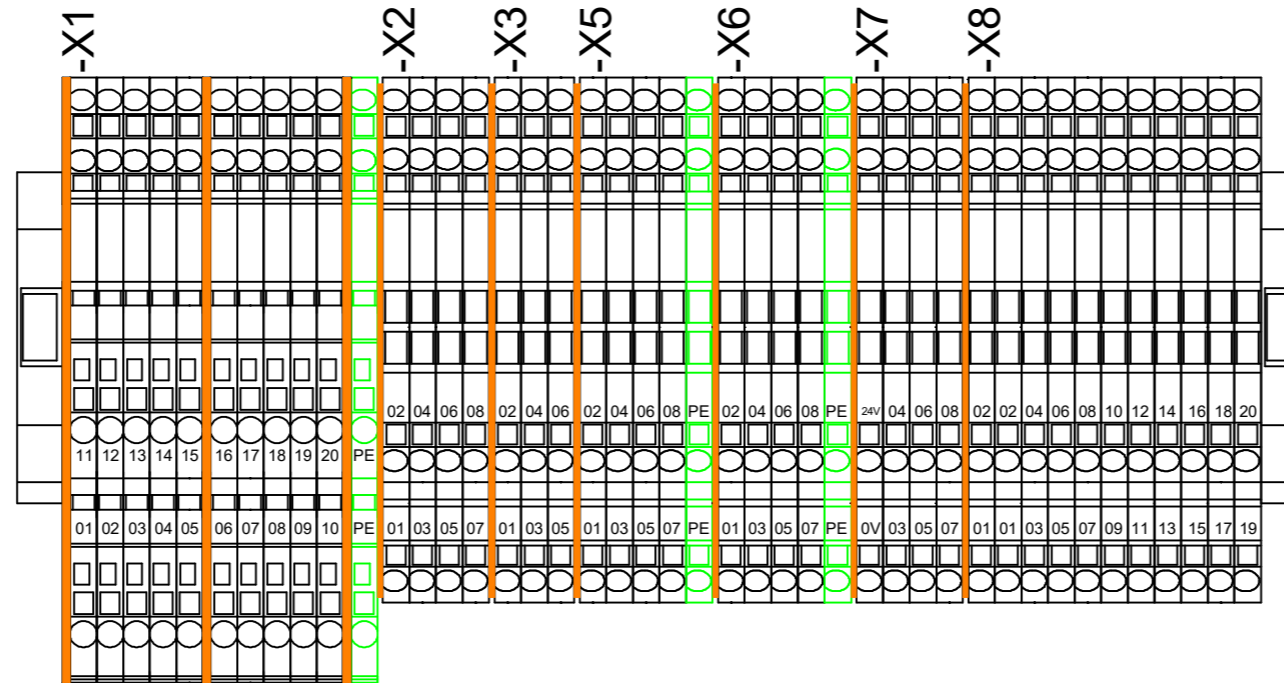



-X1:01 -M1.2 Exhaust air fan	L	-X2:01 -R1.1 Extract air damper	0V	-X5:01 -R1 Valve HW	0V	-X7:01 -B5 Pre-heater temperature sensor	-
-X1:02 -M1.2 Exhaust air fan	N	-X2:03 -R1.1 Extract air damper	24V	-X5:02 -R1 Valve HW	24V	-X7:02 -B5 Pre-heater temperature sensor	-
-X1:03 -M1.2 Spare	-	-X2:05 -R1.1 Extract air damper	B-	-X5:03 -R1 Valve HW	Signal	-X7:03 -B6 CO2 sensor	GND
-X1:04 -M2.2 Supply air fan	L	-X2:07 -R1.1 Extract air damper	A+	-X5:04 -R1 Valve HW	Not used	-X7:04 -B6 CO2 sensor	OUT
-X1:05 -M2.2 Supply air fan	N	-X2:02 -R2.2 Supply air damper	0V	-X5:05 -G1 HW circulation pump	NC	-X7:05 -B6 CO2 sensor	+VCC
-X1:06 -M2.2 Spare	-	-X2:04 -R2.2 Supply air damper	24V	-X5:06 -G1 HW circulation pump	COM	-X7:06 -	Spare terminal
-X1:07 -M3 Rotor	L	-X2:06 -R2.2 Supply air damper	B-	-X5:07 -G1 HW circulation pump	L	-X7:07 -B7 Duct temperature sensor	-
-X1:08 -M3 Rotor	N	-X2:08 -R2.2 Supply air damper	A+	-X5:08 -G1 HW circulation pump	N	-X7:08 -B7 Duct temperature sensor	-
-X1:09 -MB Modbus	0V	-X3:01 -E3 Electric pre-heating	0-10V	-X5:PE -G1 HW circulation pump	PE	-X8:0V Customer connections	24V power supply
-X1:10 -MB Modbus	24V	-X3:02 -E3 Electric pre-heating	GND	-X6:01 -R2 Valve CW/CO	0V	-X8:24V Customer connections	24V power supply
-X1:11 -MB Modbus	B-	-X3:03 -E3 Electric pre-heating	Fire	-X6:02 -R2 Valve CW/CO	24V	-X8:01 Customer connections	Fire alarm input
-X1:12 -MB Modbus	A+	-X3:04 -E3 Electric pre-heating	Fail	-X6:03 -R2 Valve CW/CO	Signal	-X8:02 Customer connections	Fire alarm input
-X1:13 -E4 Electric post-heating	0-10V	-X3:05 -E3 Electric pre-heating	Run OK	-X6:04 -R2 Valve CW/CO	Not used	-X8:03 Customer connections	Option input 1
-X1:14 -E4 Electric post-heating	GND	-X3:06 -E3 Electric pre-heating	Run OK	-X6:05 -G2 CW/CO circulation pump	NC	-X8:04 Customer connections	Option input 1
-X1:15 -E4 Electric post-heating	Fire			-X6:06 -G2 CW/CO circulation pump	COM	-X8:05 Customer connections	Option input 2
-X1:16 -E4 Electric post-heating	Fail			-X6:07 -G2 CW/CO circulation pump	L	-X8:06 Customer connections	Option input 2
-X1:17 -E4 Electric post-heating	Run OK			-X6:08 -G2 CW/CO circulation pump	N	-X8:07 Customer connections	Option input 3
-X1:18 -E4 Electric post-heating	Run OK			-X6:PE -G2 CW/CO circulation pump	PE	-X8:08 Customer connections	Option input 3
-X1:19 -B3 Temperature sensor	-					-X8:09 Customer connections	Option input 4
-X1:20 -B3 Temperature sensor	-					-X8:10 Customer connections	Option input 4
-X1:PE -PE Protective Earth	PE					-X8:11 Customer connections	A alarm output
						-X8:12 Customer connections	A alarm output
						-X8:13 Customer connections	Option output 1
						-X8:14 Customer connections	Option output 1
						-X8:15 Customer connections	Option output 2
						-X8:16 Customer connections	Option output 2
						-X8:17 Customer connections	BMS - RS485
						-X8:18 Customer connections	BMS - RS485
						-X8:19 Customer connections	Start signal
						-X8:20 Customer connections	Start signal

Manufactured by: EXHAUSTO	Project: VEX1000 - Control panel (1x230V)	Start date: 01-06-2023	Constructor: DKTSA	Page: 11
Drawing number: 2028124	Page Title: Control panel terminals	Revision date: 12-05-2026	Approved by: DKBP	Previous page: 10
		Revision: E	Scale: 1:1	Next page: 20
		Replaces revision: D	Format: A3	Pages in total: 40

Circuit diagrams

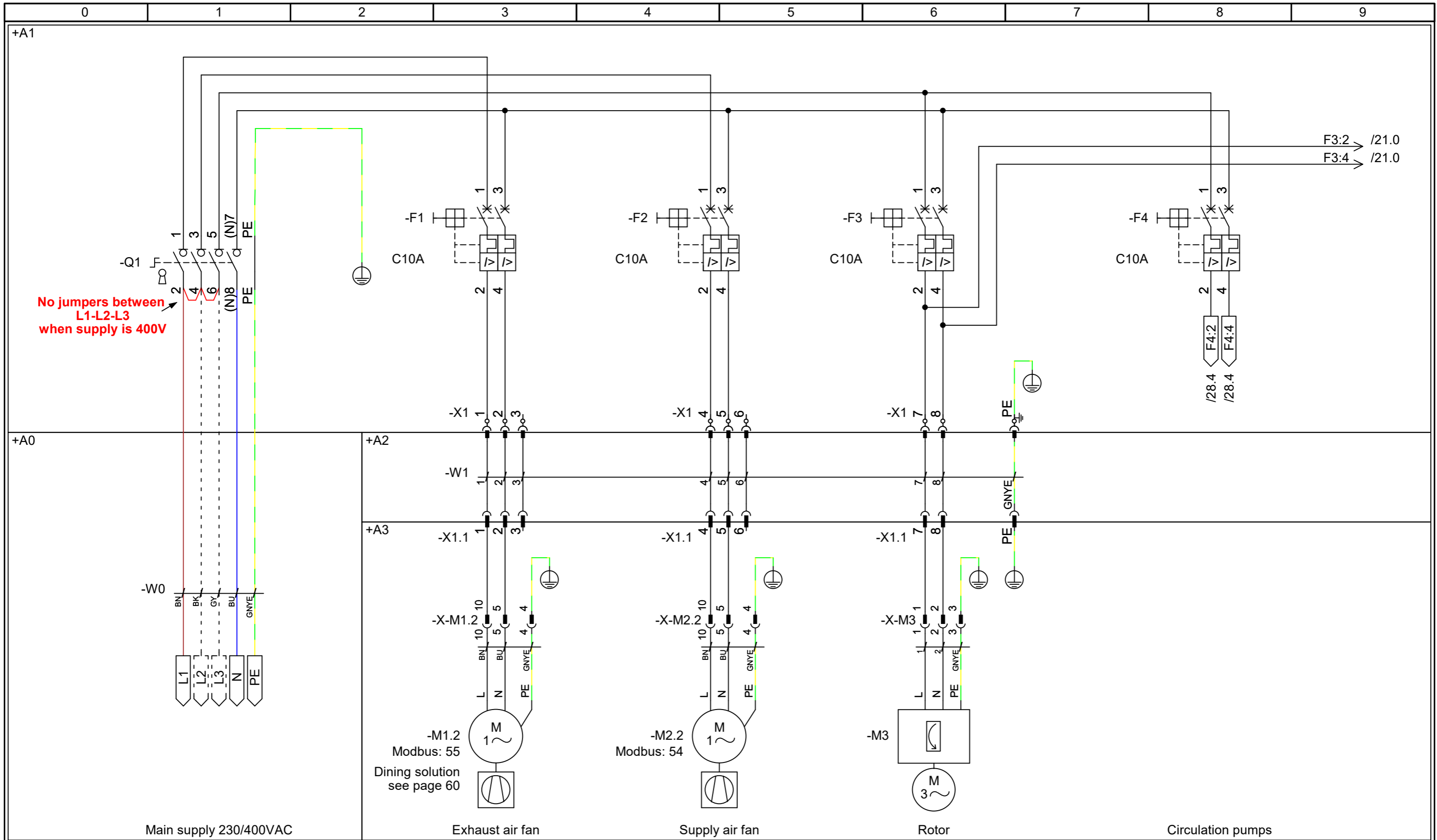
Manufactured by: EXHAUSTO	Project: VEX1000 - Control panel (1x230V)	Start date: 01-06-2023	Constructor: DKTSA	Page: Circuit diagrams
		Revision date: 12-05-2026	Approved by: DKBP	Previous page: 11
Drawing number: 2028124	Page Title: Circuit diagrams	Revision: E	Scale: 1:1	Next page: 20
		Replaces revision: D	Format: A3	Pages in total: 40



	Project: VEX1000 - Control panel (1x230V)	Start date: 01-06-2023	Constructor: DKTSA	Page: 20
	Drawing number: 2028124	Revision: E	Revision date: 12-05-2026	Approved by: DKBP
Page Title: Main current		Replaces: D	Scale: 1:1	Next page: 21
		EC no.:	Format: A3	Pages in total: 40

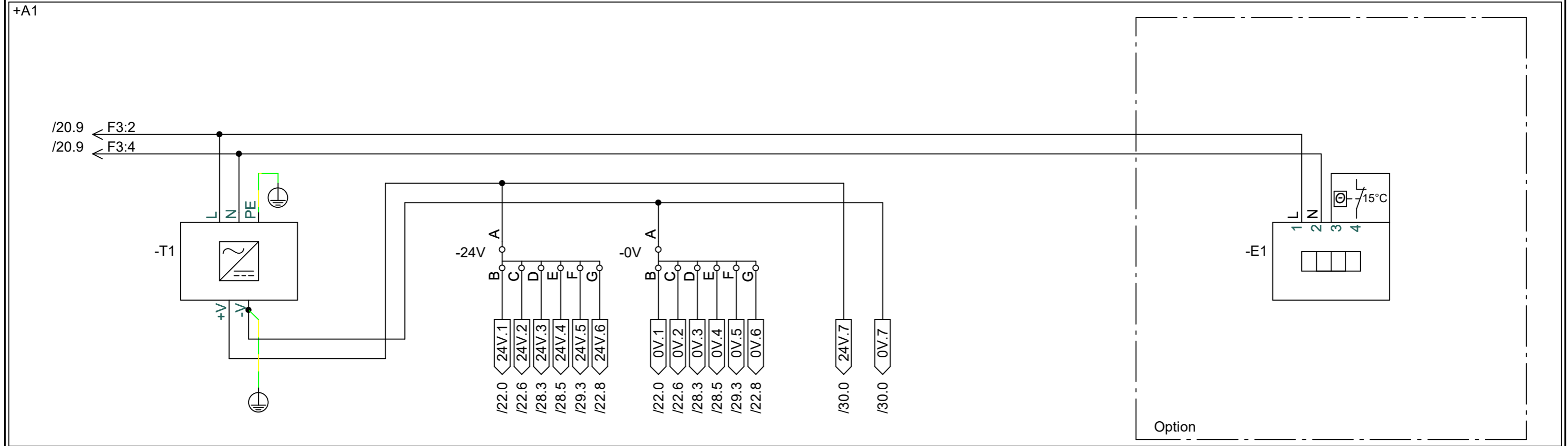

24VDC supply

Control panel heater

Manufactured by:	Project:	Start date:	Constructor:	Page:
EXHAUSTO	VEX1000 - Control panel (1x230V)	01-06-2023	DKTSA	21
Drawing number:	Page Title:	Revision date:	Approved by:	Previous page:
2028124	Pilot current	12-05-2026	DKBP	20
		Revision:	Scale:	Next page:
		E	1:1	22
		Replaces revision:	Format:	Pages in total:
		D	A3	40

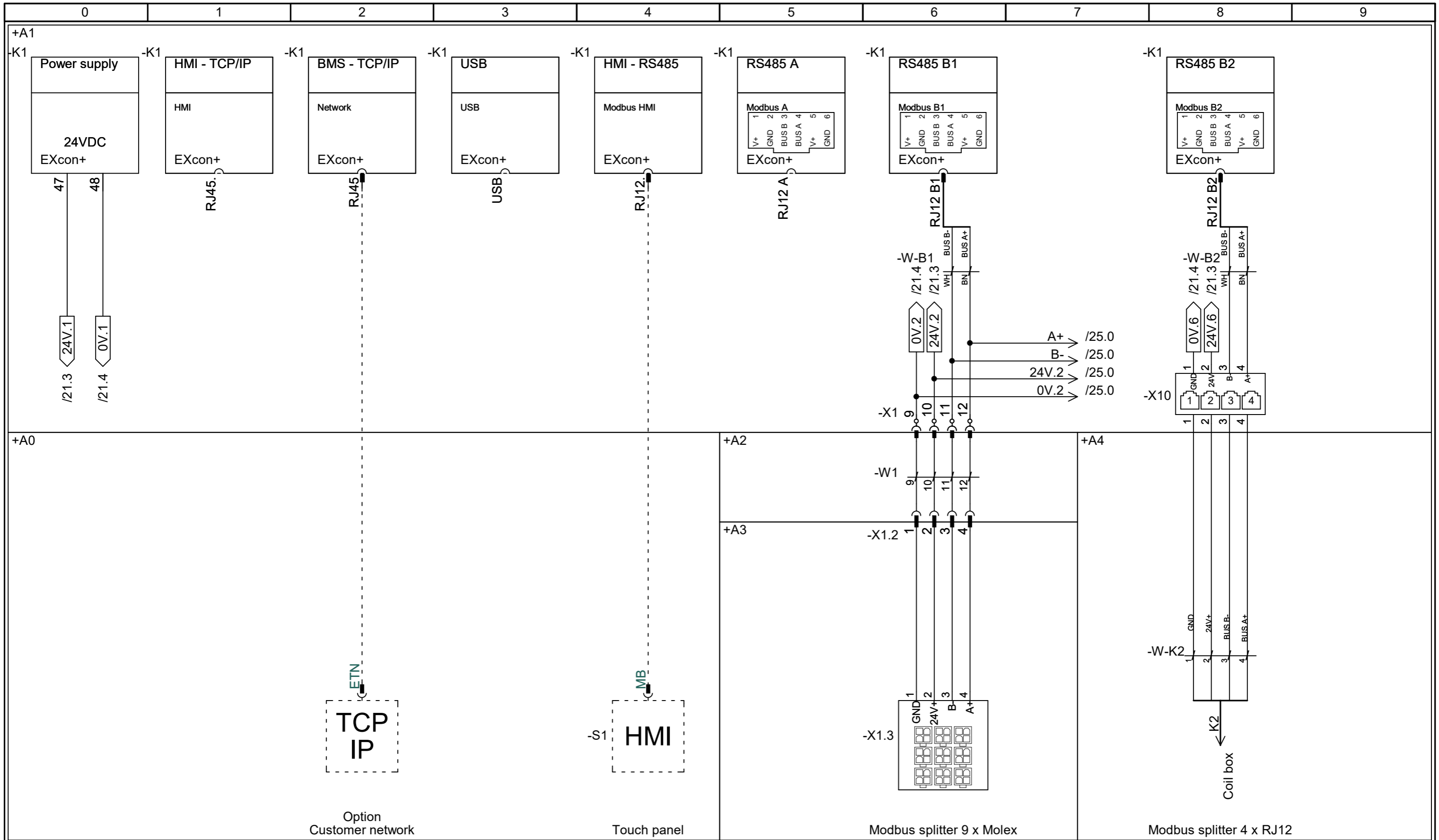

Manufactured by: EXHAUSTO	Project: VEX1000 - Control panel (1x230V)	Start date: 01-06-2023	Constructor: DKTSA	Page: 22
Drawing number: 2028124	Page Title: Standard - Modbus connections	Revision date: 12-05-2026	Approved by: DKBP	Previous page: 21
		Revision: E	Scale: 1:1	Next page: 23
		Replaces revision: D	Format: A3	Pages in total: 40

+A1

Rotor drive option

Counter-flow option

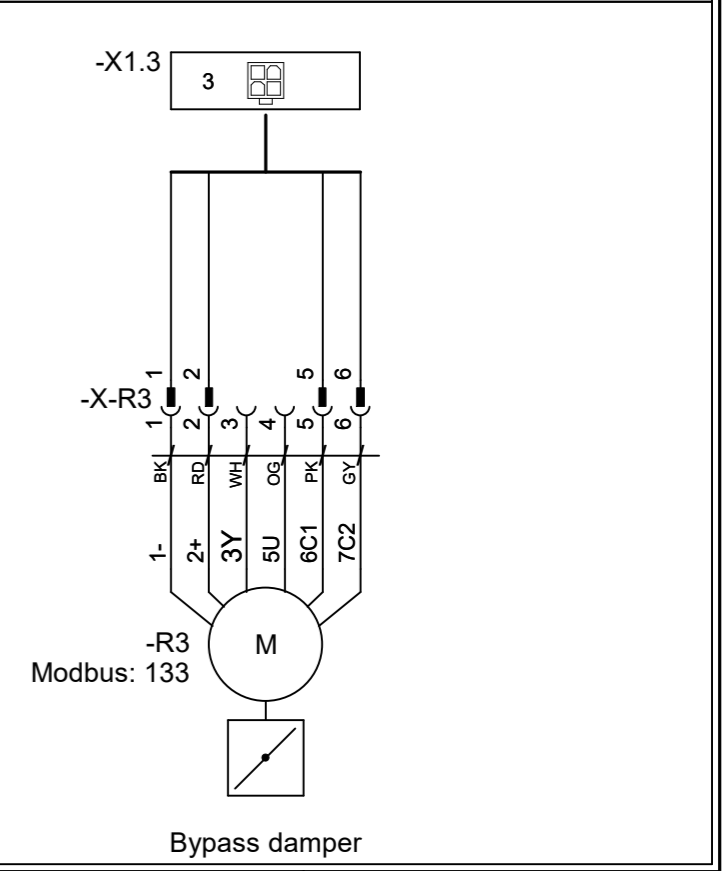
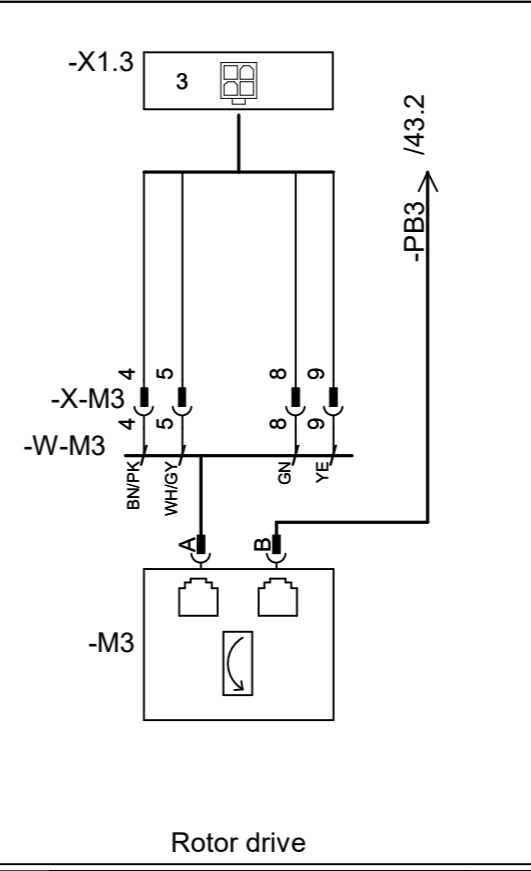
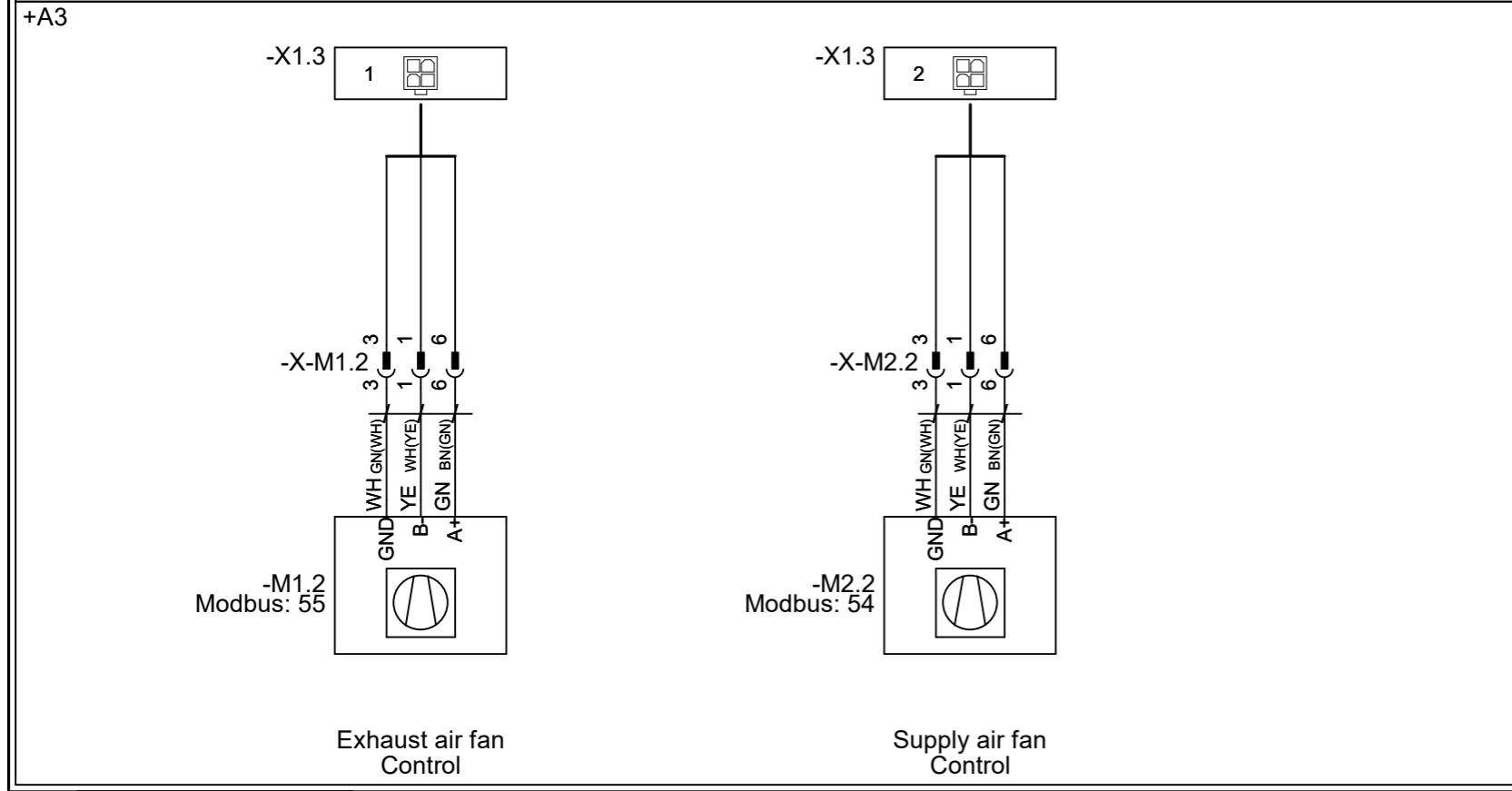

Manufactured by:	Project:	Start date:	01-06-2023	Constructor:	DKTSA	Page:	23
EXHAUSTO	VEX1000 - Control panel (1x230V)	Revision date:	12-05-2026	Approved by:	DKBP	Previous page:	22
Drawing number:	Page Title:	Revision:	E	Scale:	1:1	Next page:	24
2028124	Standard - Fan & Rotor/Bypass controls	Replaces revision:	D	Format:	A3	Pages in total:	40

+A1

+A3

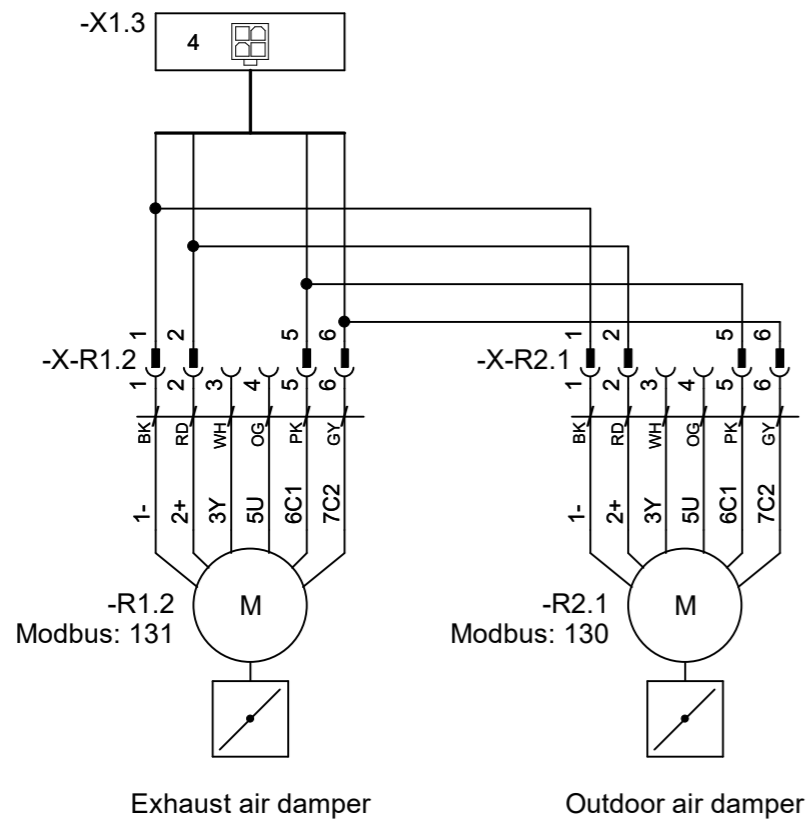

Manufactured by: EXHAUSTO	Project: VEX1000 - Control panel (1x230V)	Start date: 01-06-2023	Constructor: DKTSA	Page: 24
Drawing number: 2028124	Page Title: Standard - Dampers	Revision date: 12-05-2026	Approved by: DKBP	Previous page: 23
		Revision: E	Scale: 1:1	Next page: 25
		Replaces revision: D	Format: A3	Pages in total: 40

+A1

/22.7 ← A+
 /22.7 ← B-
 /22.7 ← 24V.2
 /22.7 ← 0V.2

+A3

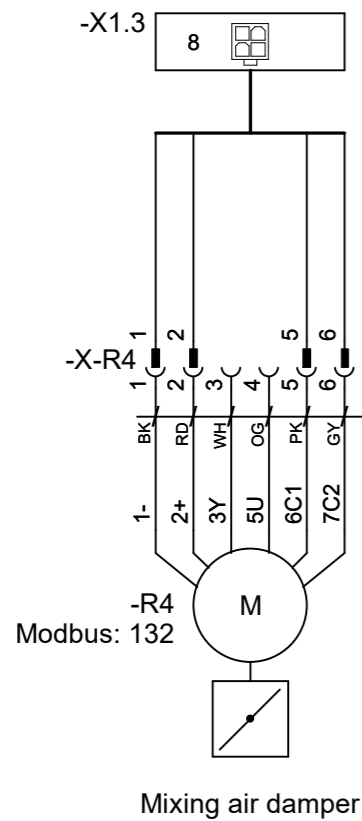

+A4

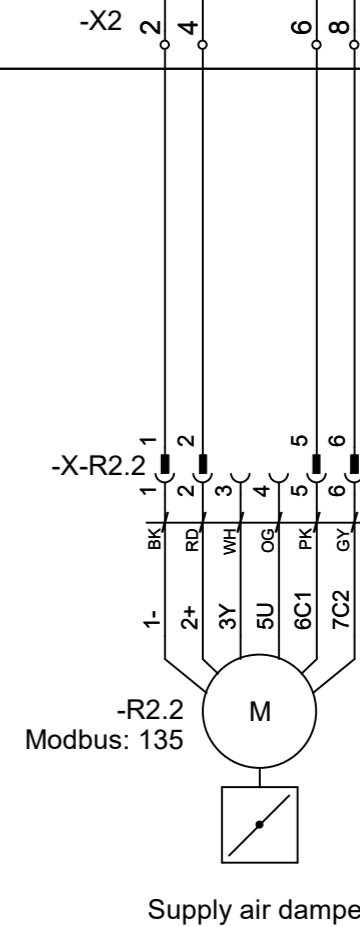
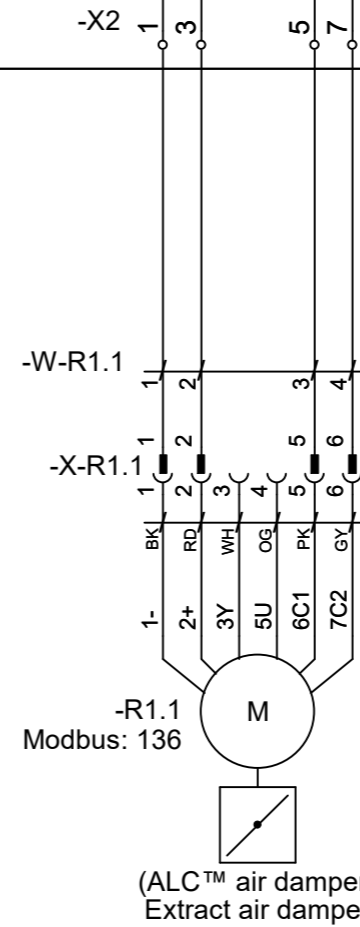

Manufactured by:	Project:	Start date:	Constructor:	Page:
EXHAUSTO	VEX1000 - Control panel (1x230V)	01-06-2023	DKTSA	25
Drawing number:	Page Title:	Revision date:	Approved by:	Previous page:
2028124	Options - Dampers	12-05-2026	DKBP	24
		Revision:	Scale:	Next page:
		E	1:1	26
		Replaces revision:	Format:	Pages in total:
		D	A3	40

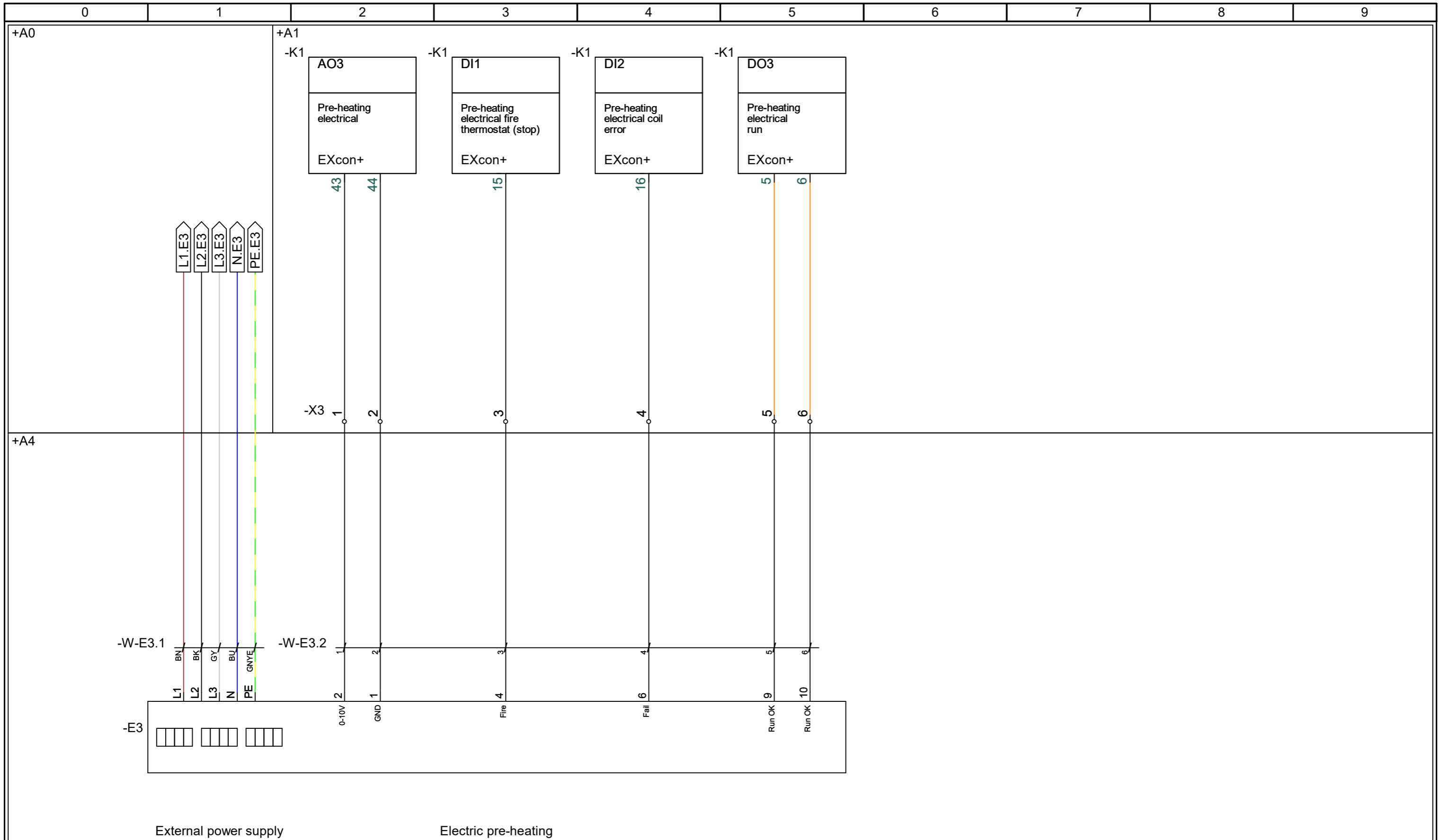

Manufactured by: EXHAUSTO	Project: VEX1000 - Control panel (1x230V)	Start date: 01-06-2023	Constructor: DKTSA	Page: 26
Drawing number: 2028124	Page Title: Options - Pre-heating controls	Revision date: 12-05-2026	Approved by: DKBP	Previous page: 25
		Revision: E	Scale: 1:1	Next page: 27
		Replaces revision: D	Format: A3	Pages in total: 40

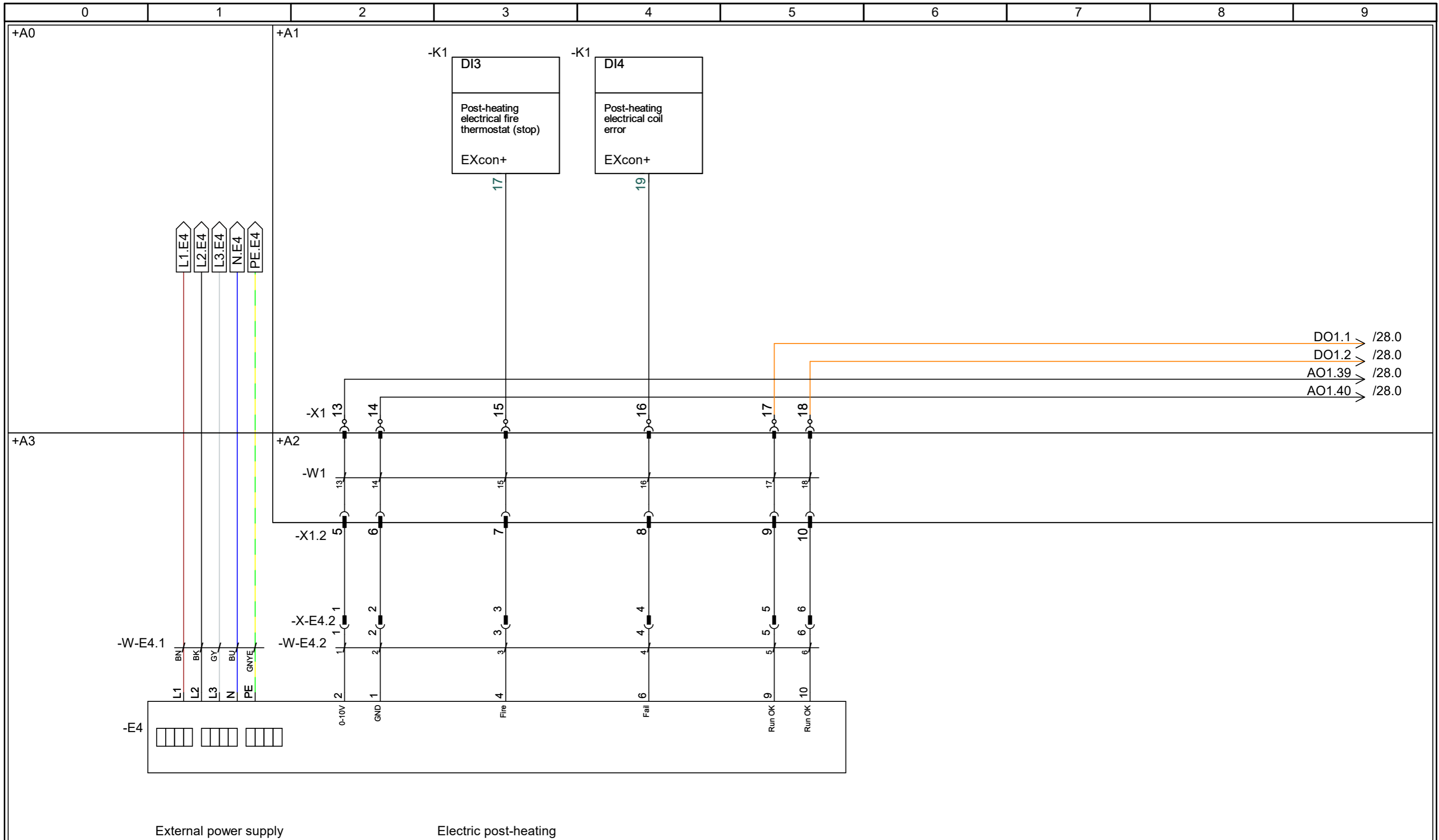

Manufactured by: EXHAUSTO	Project: VEX1000 - Control panel (1x230V)	Start date: 01-06-2023	Constructor: DKTSA	Page: 27
Drawing number: 2028124	Page Title: Options - Post-heating controls	Revision date: 12-05-2026	Approved by: DKBP	Previous page: 26
		Revision: E	Scale: 1:1	Next page: 28
		Replaces revision: D	Format: A3	Pages in total: 40

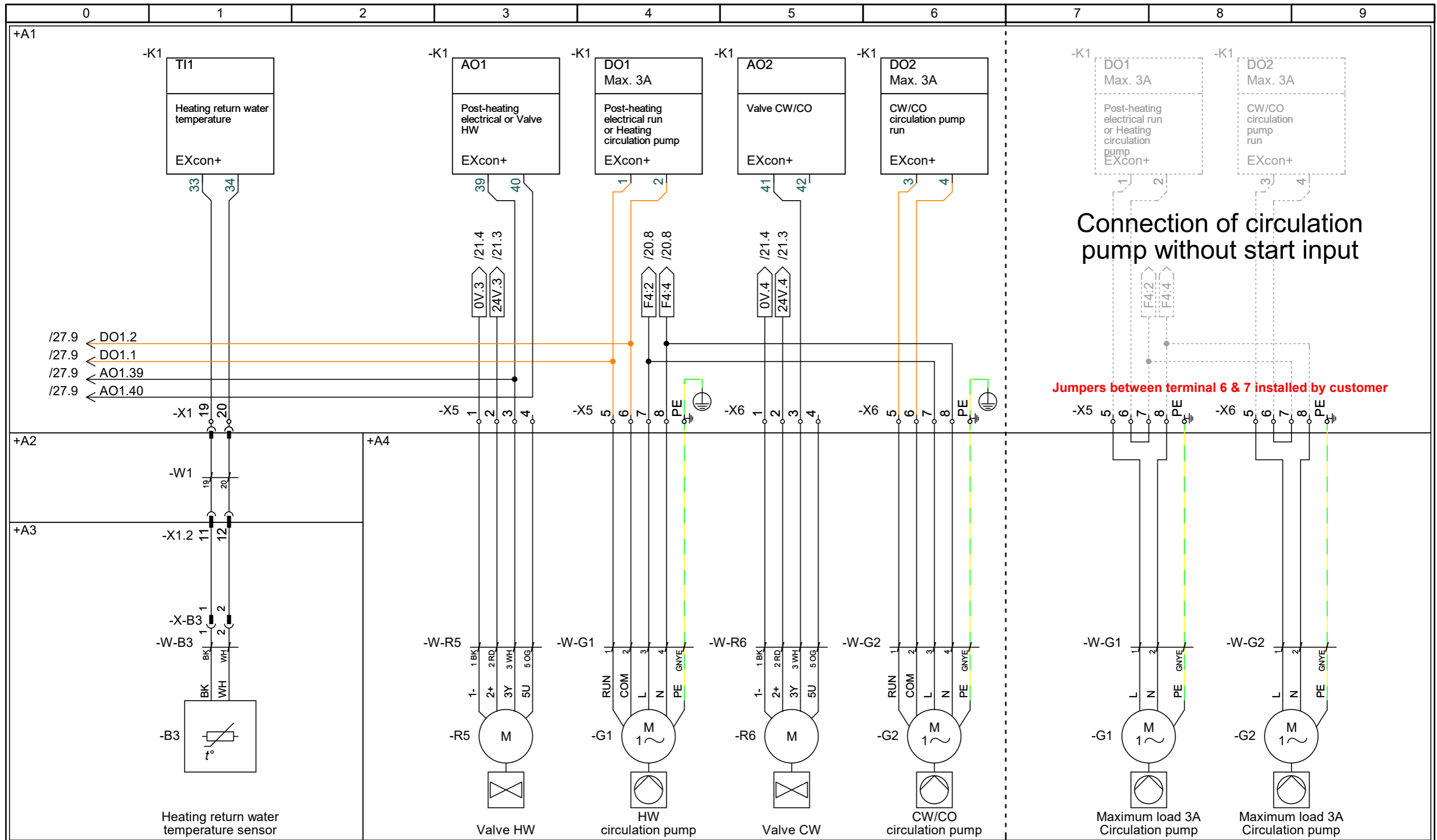

Manufactured by: EXHAUSTO	Project: VEX1000 - Control panel (1x230V)	Start date: 01-06-2023	Constructor: DKTSA	Page: 28
Drawing number: 2028124	Page Title: Options - HW/CW/CO controls	Revision date: 12-05-2026	Approved by: DKBP	Previous page: 27
		Revision: E	Scale: 1:1	Next page: 29
		Replaces revision: D	Format: A3	Pages in total: 40

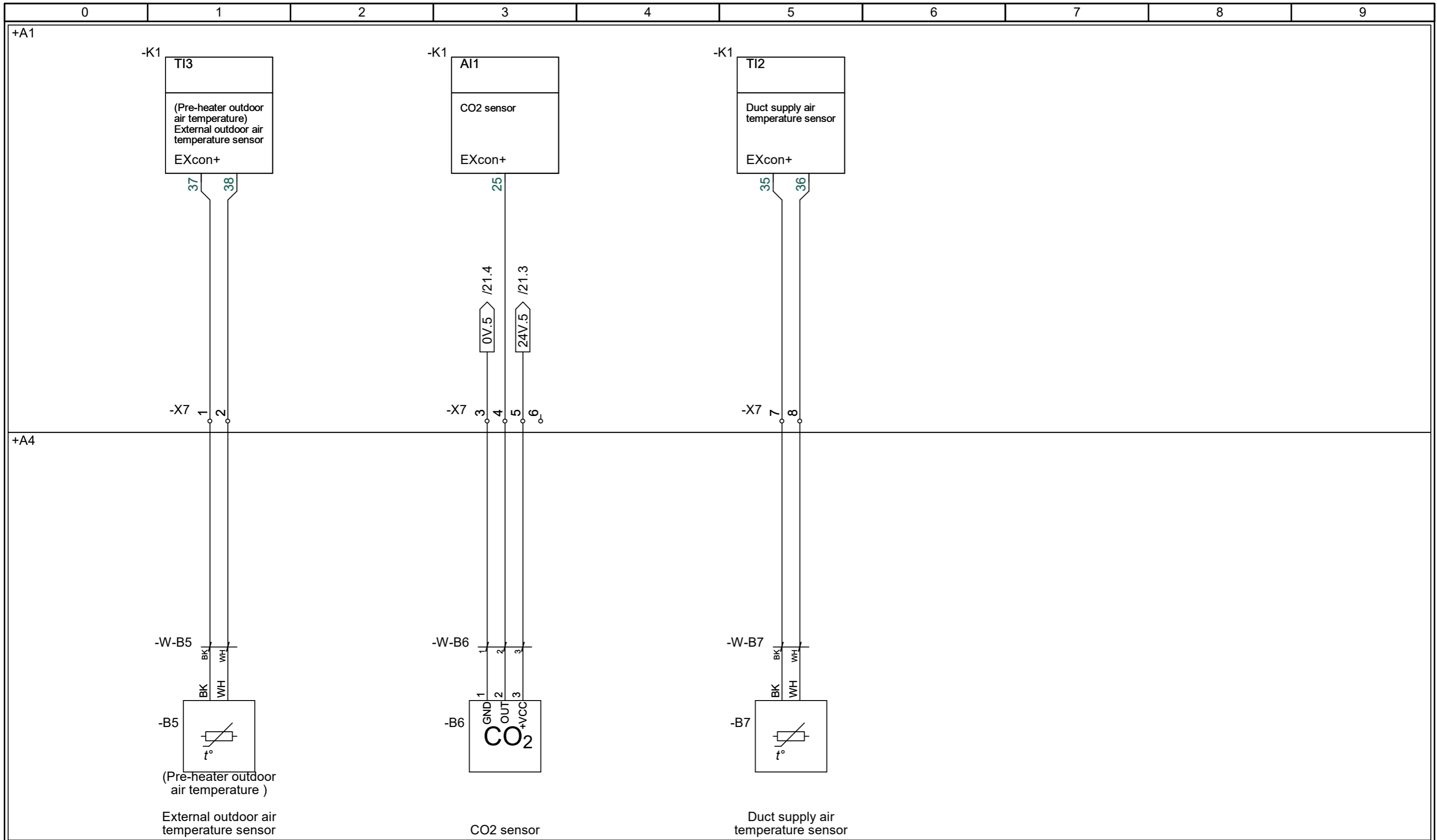

Manufactured by: EXHAUSTO	Project: VEX1000 - Control panel (1x230V)	Start date: 01-06-2023	Constructor: DKTSA	Page: 29
Drawing number: 2028124	Page Title: Options - Temperature & CO2 sensors	Revision date: 12-05-2026	Approved by: DKBP	Previous page: 28
		Revision: E	Scale: 1:1	Next page: 30
		Replaces revision: D	Format: A3	Pages in total: 40

Pressure & temperature transmitters

Manufactured by: EXHAUSTO	Project: VEX1000 - Control panel (1x230V)	Start date: 01-06-2023	Constructor: DKTSA	Page: PTH
		Revision date: 12-05-2026	Approved by: DKBP	Previous page: 30
Drawing number: 2028124	Page Title: Pressure & temperature transmitters	Revision: E	Scale: 1:1	Next page: 40
		Replaces revision: D	Format: A3	Pages in total: 40

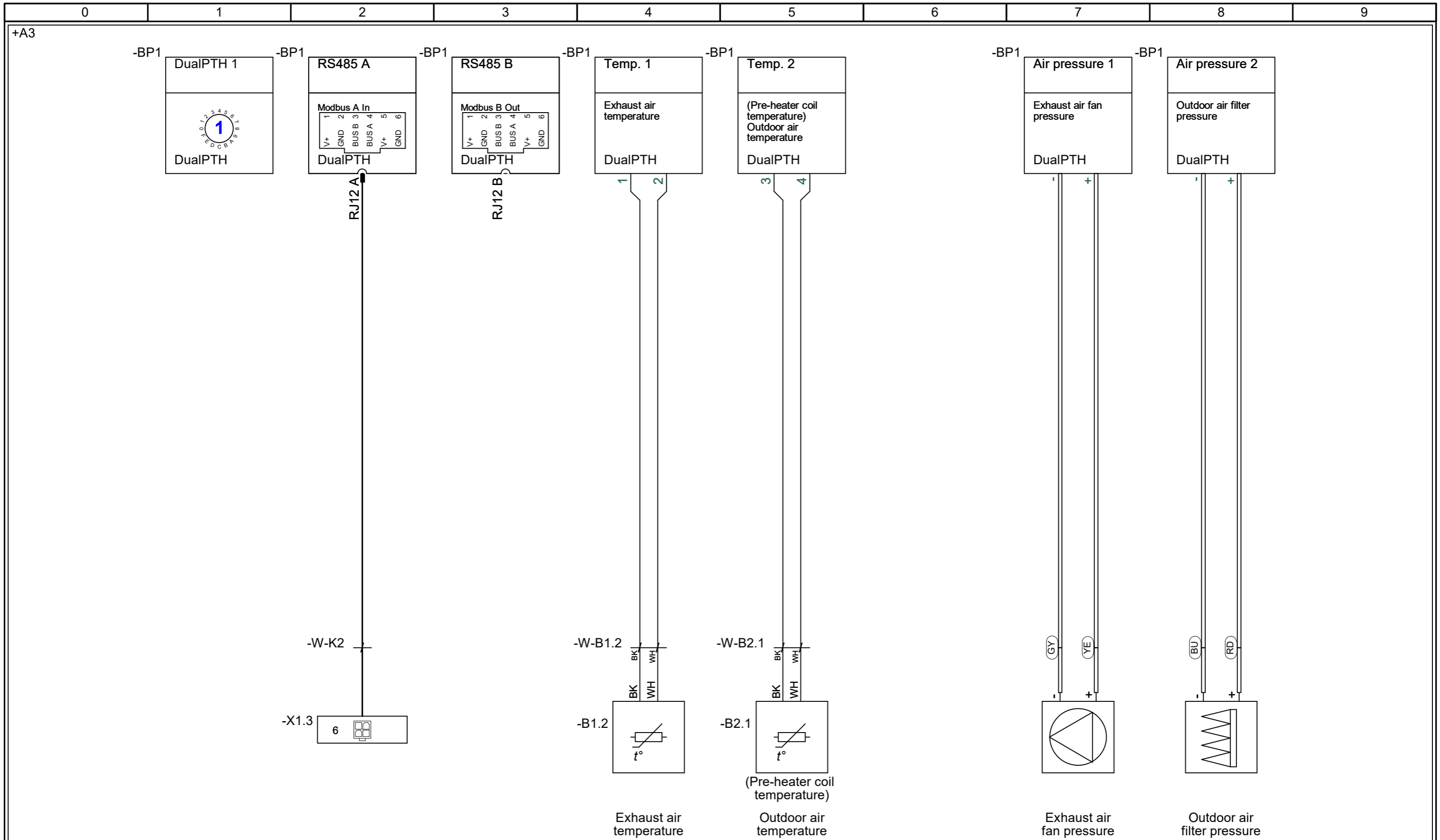

Manufactured by: EXHAUSTO	Project: VEX1000 - Control panel (1x230V)	Start date: 01-06-2023	Constructor: DKTSA	Page: 40
Drawing number: 2028124	Page Title: Standard - Dual PTH 1	Revision date: 12-05-2026	Approved by: DKBP	Previous page: 30
		Revision: E	Scale: 1:1	Next page: 41
		Replaces revision: D	Format: A3	Pages in total: 40

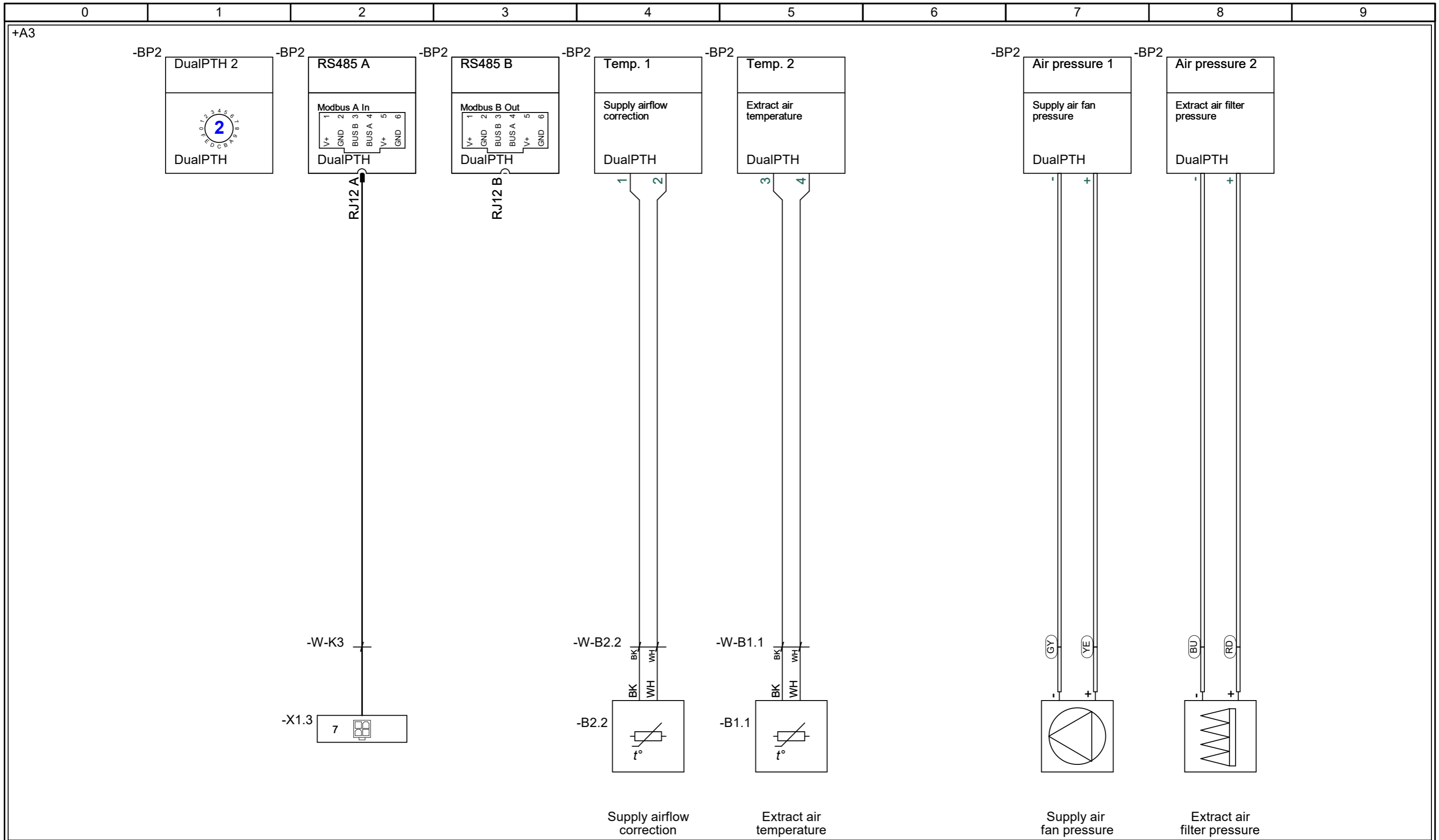

Manufactured by: EXHAUSTO	Project: VEX1000 - Control panel (1x230V)	Start date: 01-06-2023	Constructor: DKTSA	Page: 41
Drawing number: 2028124	Page Title: Standard - Dual PTH 2	Revision date: 12-05-2026	Approved by: DKBP	Previous page: 40
		Revision: E	Scale: 1:1	Next page: 42
		Replaces revision: D	Format: A3	Pages in total: 40

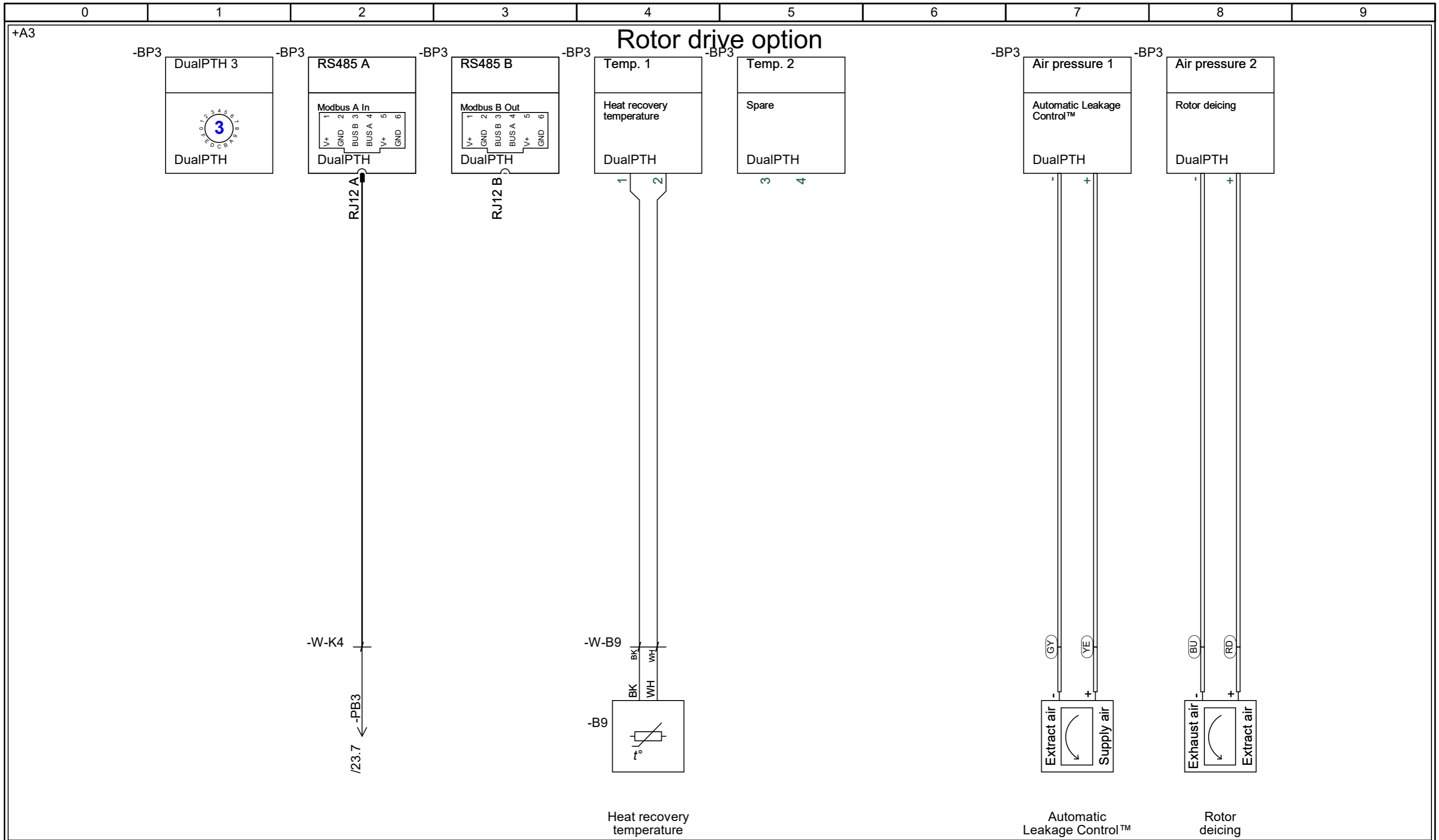

Manufactured by: EXHAUSTO	Project: VEX1000 - Control panel (1x230V)	Start date: 01-06-2023	Constructor: DKTSA	Page: 42
Drawing number: 2028124	Page Title: Option - ALC™ - Rotor deicing - Heat recovery temp.	Revision date: 12-05-2026	Approved by: DKBP	Previous page: 41
		Revision: E	Scale: 1:1	Next page: 43
		Replaces revision: D	Format: A3	Pages in total: 40

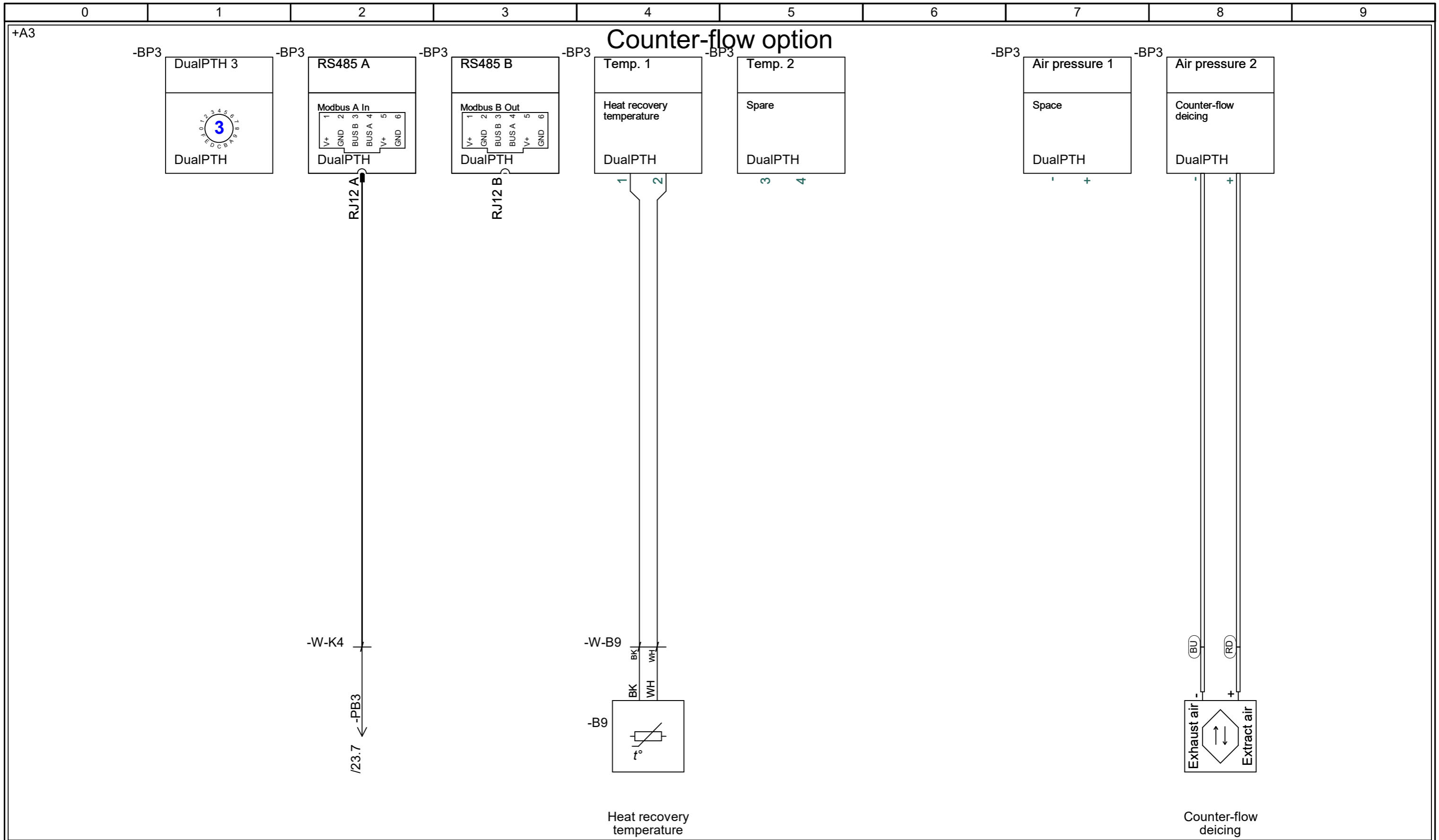

Manufactured by: EXHAUSTO	Project: VEX1000 - Control panel (1x230V)	Start date: 01-06-2023	Constructor: DKTSA	Page: 43
Drawing number: 2028124	Page Title: Option - Counter-flow deicing - Heat recovery temp.	Revision date: 12-05-2026	Approved by: DKBP	Previous page: 42
		Revision: E	Scale: 1:1	Next page: 50
		Replaces revision: D	Format: A3	Pages in total: 40

Extension modules

Manufactured by: EXHAUSTO	Project: VEX1000 - Control panel (1x230V)	Start date: 01-06-2023	Constructor: DKTSA	Page: EXT
		Revision date: 12-05-2026	Approved by: DKBP	Previous page: 43
Drawing number: 2028124	Page Title: Extension modules	Revision: E	Scale: 1:1	Next page: 50
		Replaces revision: D	Format: A3	Pages in total: 40

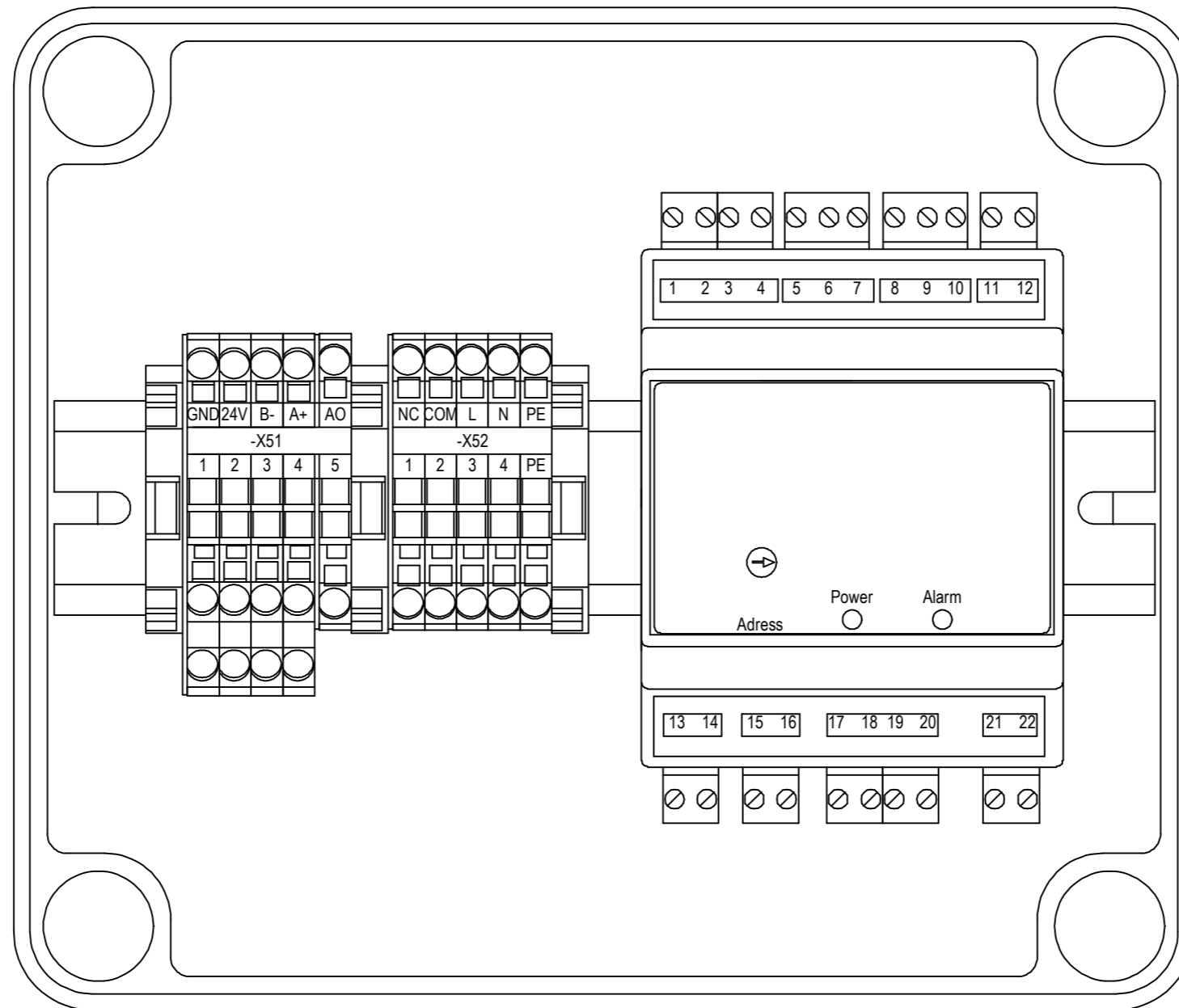

Manufactured by: EXHAUSTO	Project: VEX1000 - Control panel (1x230V)	Start date: 01-06-2023	Constructor: DKTSA	Page: 50
Drawing number: 2028124	Page Title: Option - Coil control box layout	Revision date: 12-05-2026	Approved by: DKBP	Previous page: 43
		Revision: E	Scale: 1:1	Next page: 51
		Replaces revision: D	Format: A3	Pages in total: 40

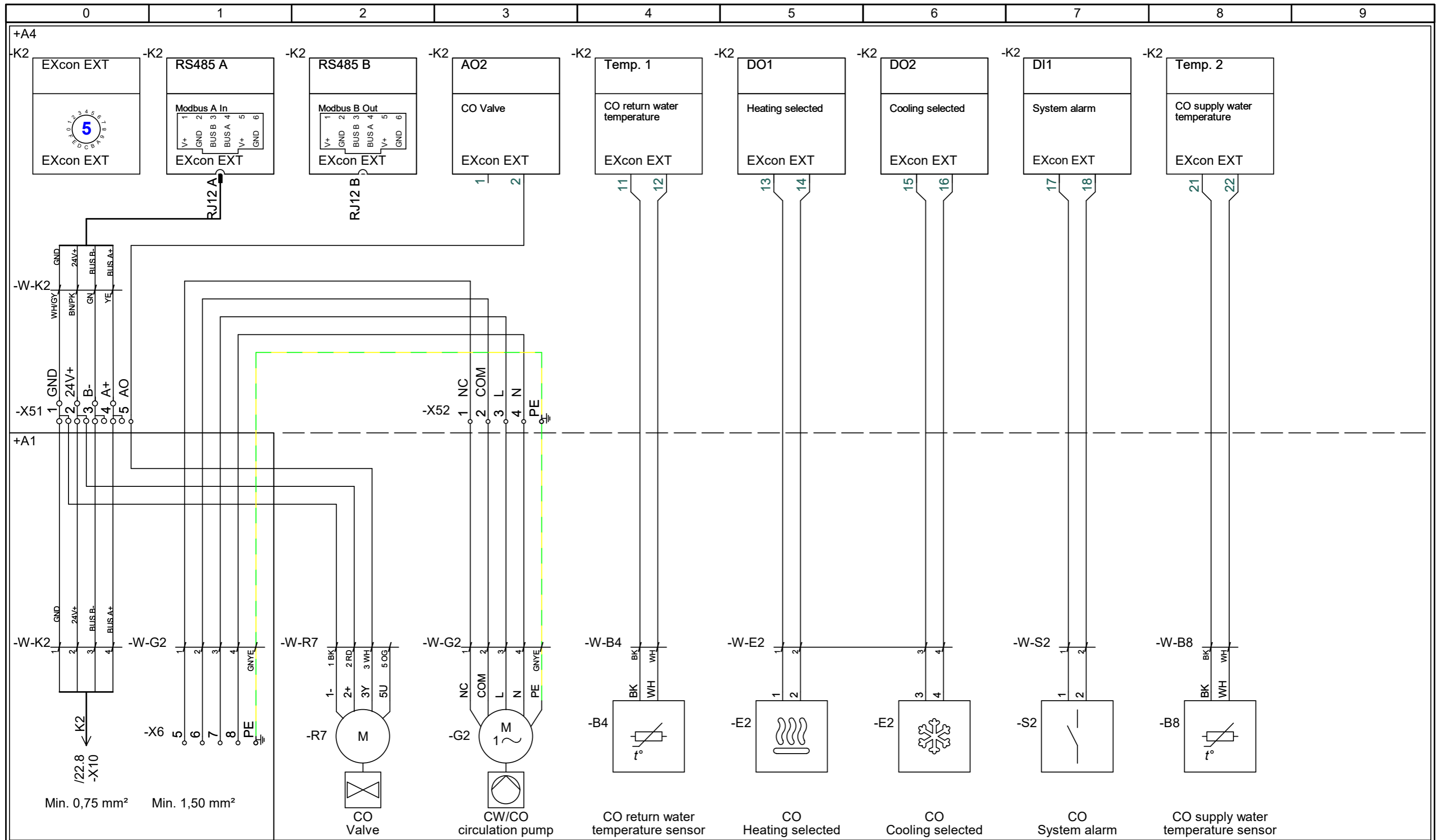

Manufactured by: EXHAUSTO	Project: VEX1000 - Control panel (1x230V)	Start date: 01-06-2023	Constructor: DKTSA	Page: 51
Drawing number: 2028124	Page Title: Option - Combi Coil	Revision date: 12-05-2026	Approved by: DKBP	Previous page: 50
		Revision: E	Scale: 1:1	Next page: 52
		Replaces revision: D	Format: A3	Pages in total: 40

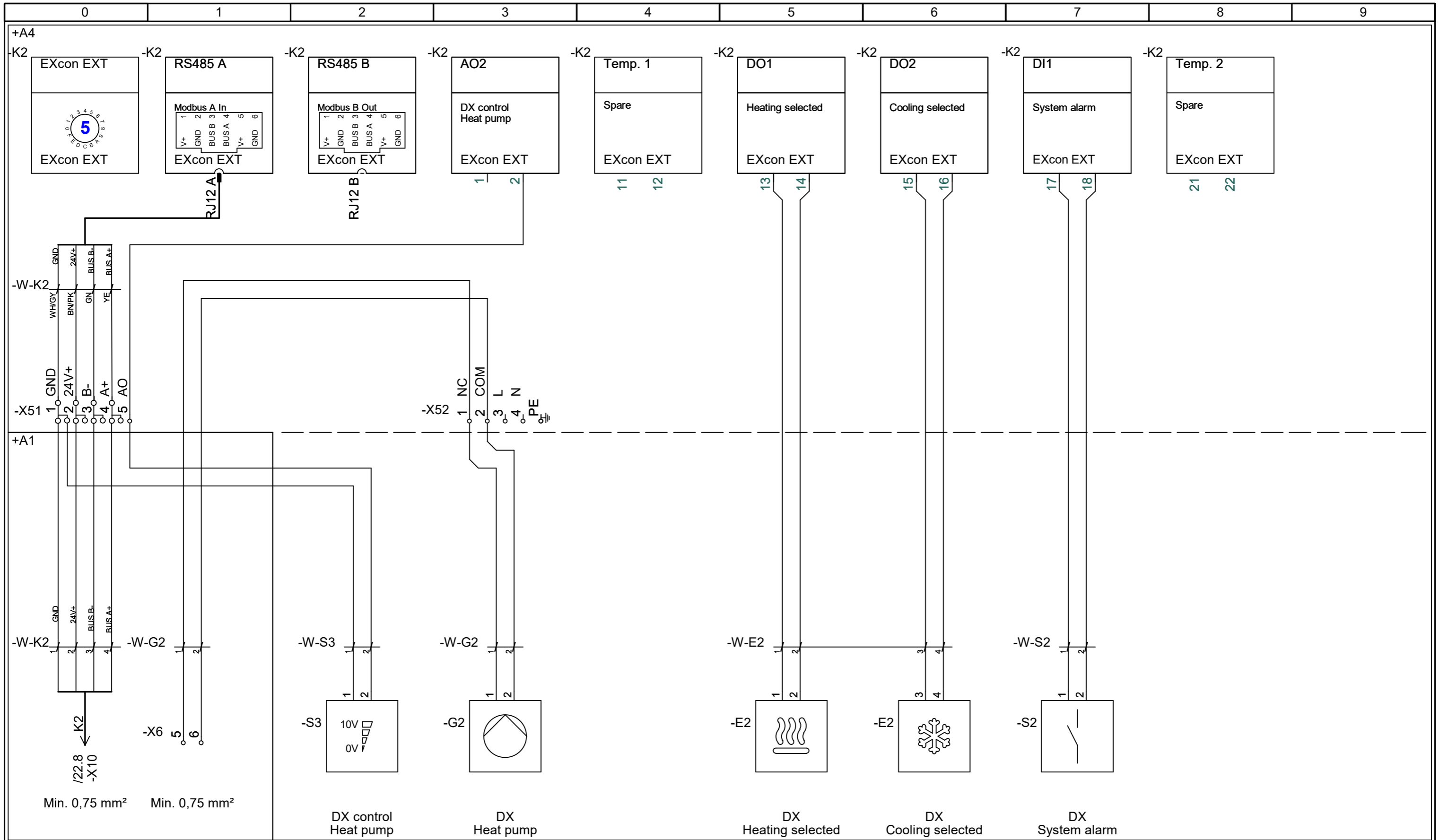

Manufactured by: EXHAUSTO	Project: VEX1000 - Control panel (1x230V)	Start date: 01-06-2023	Constructor: DKTSA	Page: 52
Drawing number: 2028124	Page Title: Option - Direct Expansion Heat pump	Revision date: 12-05-2026	Approved by: DKBP	Previous page: 51
		Revision: E	Scale: 1:1	Next page: 53
		Replaces revision: D	Format: A3	Pages in total: 40

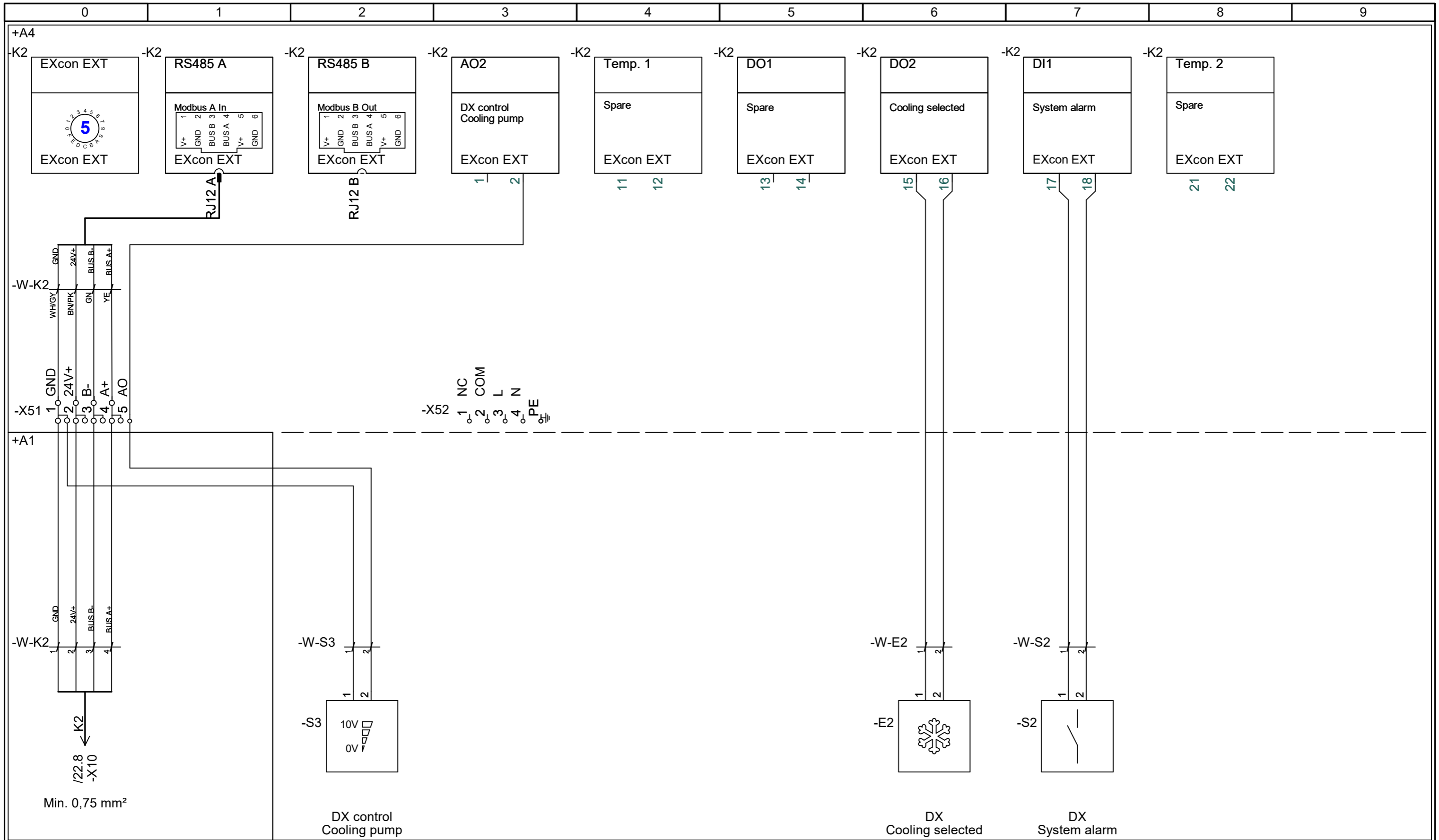

Manufactured by: EXHAUSTO	Project: VEX1000 - Control panel (1x230V)	Start date: 01-06-2023	Constructor: DKTSA	Page: 53
		Revision date: 12-05-2026	Approved by: DKBP	Previous page: 52
Drawing number: 2028124	Page Title: Option - Direct Expansion Cooling	Revision: E	Scale: 1:1	Next page: 60
		Replaces revision: D	Format: A3	Pages in total: 40

Option - Kitchen Solution

Manufactured by: EXHAUSTO	Project: VEX1000 - Control panel (1x230V)	Start date: 01-06-2023	Constructor: DKTSA	Page: KS
		Revision date: 12-05-2026	Approved by: DKBP	Previous page: 53
Drawing number: 2028124	Page Title: Option - Kitchen Solution	Revision: E	Scale: 1:1	Next page: 60
		Replaces revision: D	Format: A3	Pages in total: 40

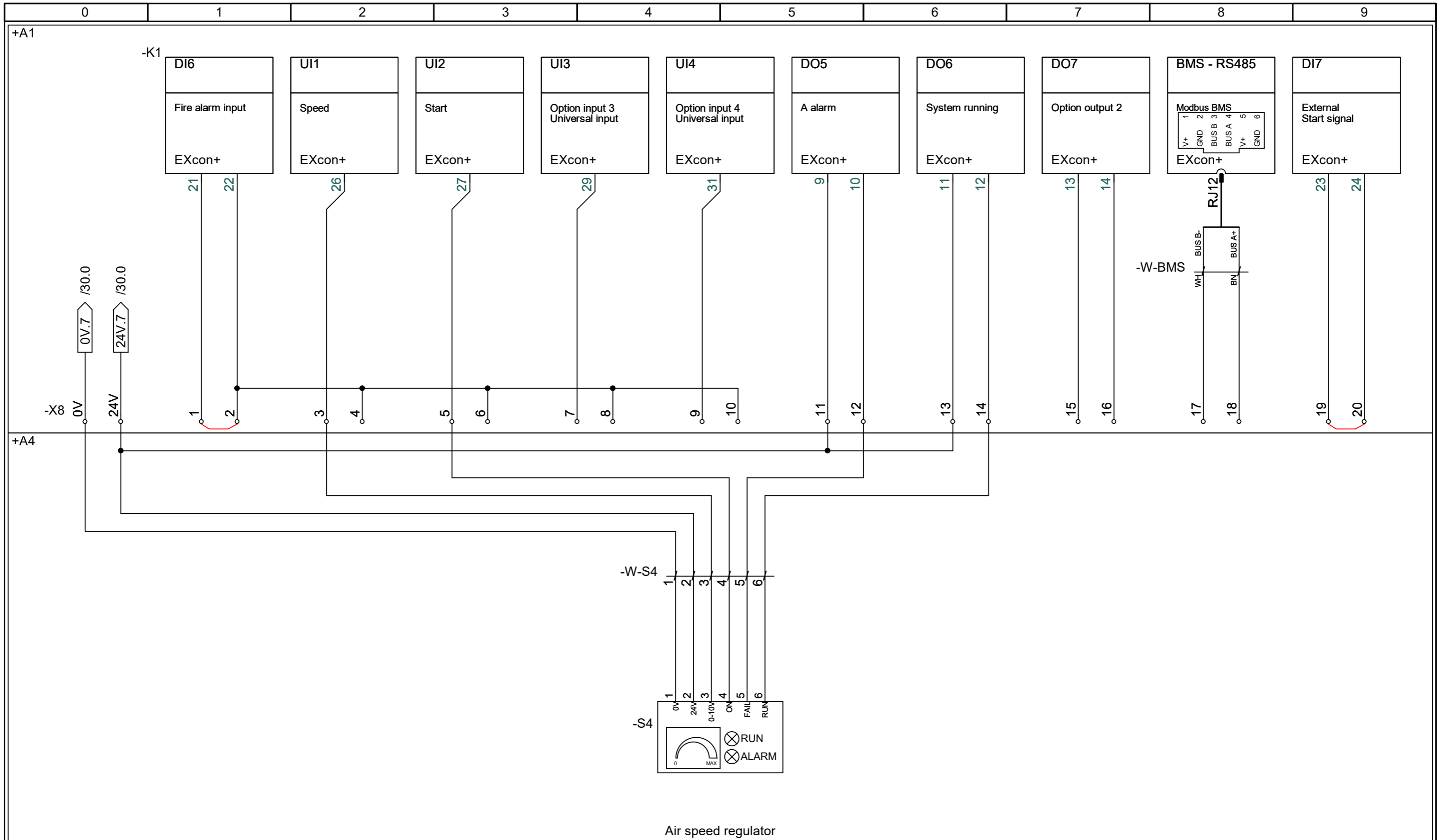

Manufactured by: EXHAUSTO	Project: VEX1000 - Control panel (1x230V)	Start date: 01-06-2023	Constructor: DKTSA	Page: 61
Drawing number: 2028124	Page Title: Option - Kitchen Solution - Air speed	Revision date: 12-05-2026	Approved by: DKBP	Previous page: 60
		Revision: E	Scale: 1:1	Next page: .
		Replaces revision: D	Format: A3	Pages in total: 40



Scan code and go to addresses at
www.exhausto.dk

EXHAUSTO