

# 1 NON FIRE-RATED EXHAUST BOX FANS

Ventilation box fan

## BESB50041EC2S

### BESB50041EC2S

Box fan with EC motor – available in seven sizes. Low energy consumption, low sound and noise level and low service costs.

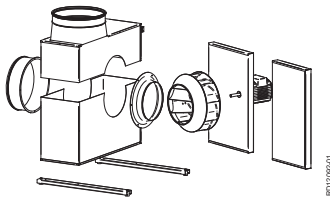

### PRODUCT BENEFITS

- Low operating costs
- Longer service intervals
- Low noise level

### Product description

DESCRIPTION:

BESB box fans are low-energy fans with backward-curved B-wheels and sound-dampening insulation.

BESB is available in 7 sizes, with 9 capacities - BESB250, BESB315, BESB400, BESB500, BESB560, BESB630 (BESB631), and BESB710

All are delivered with measuring points for airflow measurement, except BESB250.

MOTORS:

All BESB box fans are equipped with EC motors. Get an overview of the individual sizes below.

TEMPERATURE:

BESB box fans can withstand temperatures up to 80 °C during normal operation.

Smoke Extract Fans

If you need a certified smoke extract fan, we refer to the FSB box fan, which is described under the FIRE PROTECTION product group.

BESB250-500:

- Can be ordered in an outdoor version (OD), which has the following characteristics.
- Temperature range - withstands hot air up to 200 °C
- Condensate drain for position A

BESB560-710:

- Always suitable for outdoor mounting
- Condensate drain is included, but not installed

### Accessories

Description	Variants
FLF500-Ø500, flex connection	FLF500
MAC12 constant pressure regulator	MAC12
HW050X08002U0UL	EFC1P2

## Ventilation box fan

**BESB50041EC2S****BESB50041EC2S**

## Fan data

Max. Total efficiency (A-D) (%)	71,5
Ventilation energy class - Average climate	D
Efficiency level requirements	64, N(2015)
ECO efficiency level during optimal operating point	89,6
EC motor	EC motor with integral VSD
Nominal speed (RPM)	1420
Overload protection	Integrated in motor control
Engine power (kW)	1,1

## Dimensional data

A (mm)	990
B (mm)	860
C (mm)	425
G (mm)	850
E Ø (mm)	500
Weight (kg)	88

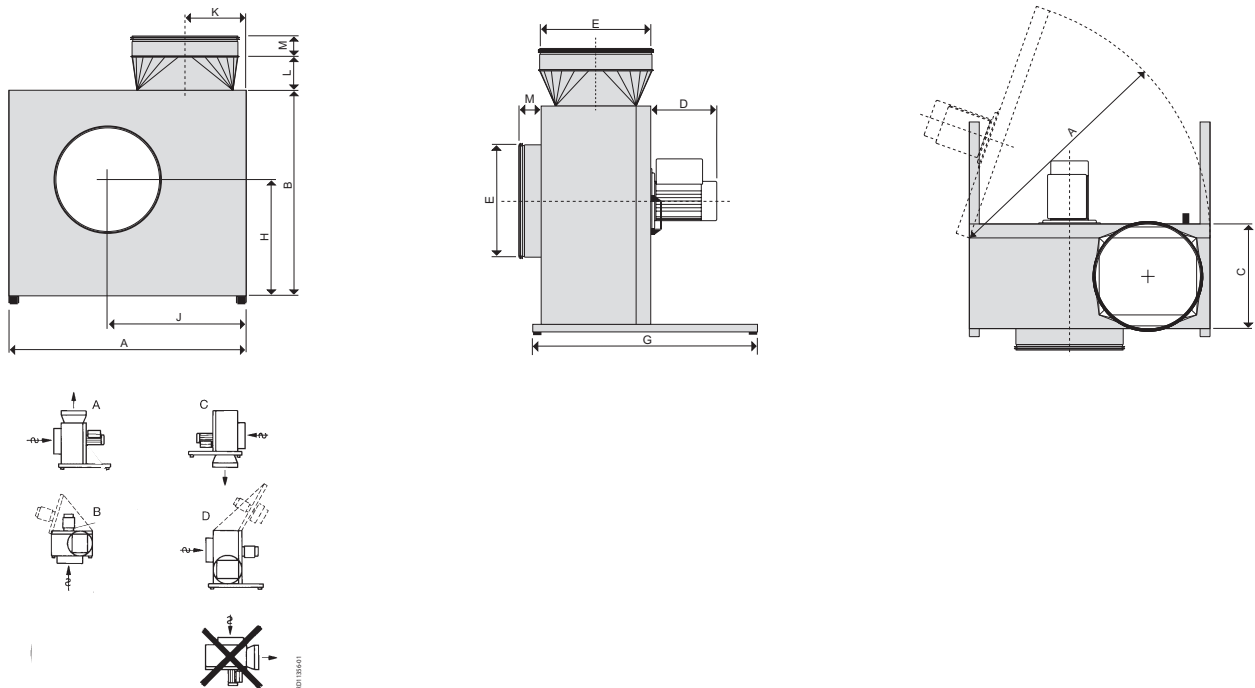

The box fan can be mounted in different positions, however, space for insulating the ducts must be taken into account.

In installation options B and D, with the door facing upwards, special fittings must be used to hold the door (accessory).

The box fan should not be screwed onto the supporting base. The base must be stable and vibration free, with no sagging. The outdoor model can be installed according to options A and B.

## Electrical datas

Voltage (V)	1x230
Frequency (Hz)	50
Max. current (A)	8,5
Engine power (kW)	1,1

## Regulatory data

Ventilation energy class - Average climate	D
--	---

Ventilation box fan

**BESB50041EC2S**  
**BESB50041EC2S**

Installation



BESB box fans are made from Aluzinc® AZ185 class C4 in accordance with EN/ISO12944-2 and insulated with 50-mm mineral wool.

As standard BESB can handle a gas temperature of up to 80°C, but in an OD version can withstand temperatures right up to 200 C.

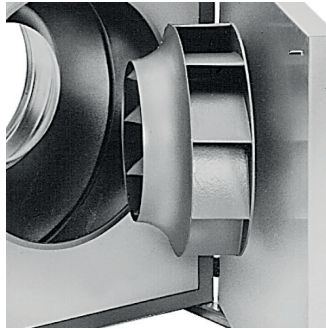

The fan wheel is a B-wheel. For BESB250, BESB315, BESB400, and BESB500, the wheel is made of cast aluminium. For BESB560, BESB630, BESB631, and BESB710, the wheel is made of steel.

It has backward-curved blades, which ensure low energy consumption, and also has the advantage that dirt does not easily get stuck and reduce the wheel's efficiency.



The spigots on BESB have rubber gaskets, with a transition piece on the extract side specially developed for minimum pressure drop.

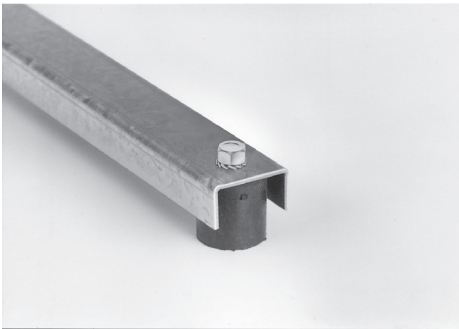

To minimise noise and vibration, the box fan is fitted as standard with efficient vibration dampers mounted on brackets.

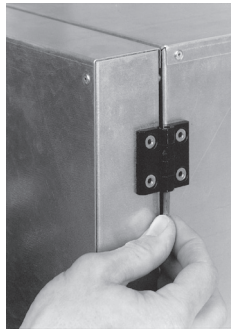

The BESB250-500 box fan is mounted with split hinges, which enable the door to be removed for installation and servicing, even in very confined conditions or for transport to difficult locations.

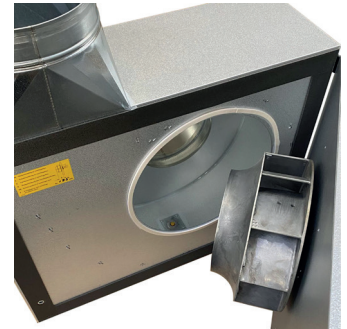

The BESB box fan is designed to transport air with an air humidity of less than 80% RH.

BESB is available in a special OD variant with a condensation outlet for air with over 80% RH.

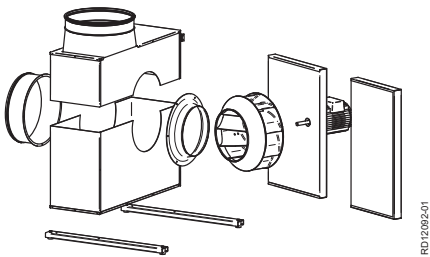

If there are problems with transporting the BESB box fans in one piece, they can be ordered as SPLIT execution.

- > The box fans must be assembled by a fitter approved by EXHAUSTO
- > The box fans must be tested before the fitter hands over the fan

BESB560, BESB630, BESB631 and BESB710 cannot be obtained as SPLIT

RD12092401

## Ventilation box fan

**BESB50041EC2S**

BESB50041EC2S



The BESB box fan is a low-energy fan, in which fan housing, centrifugal impeller and motor all work together as one technology.

All BESB box fans fulfil the 2015 requirements laid down in the Ecodesign Directive EC327/2011.

BESB is listed by the Danish electrical power utility companies as an 'energy-saving fan'® – that is a highly energy-efficient fan.

All BESB box fans are equipped with an EC motor. BESB box fans are equipped with an EC motor, which is directly connected to the fan impeller.

The EC motor for IP54 is a permanent-magnet motor of class IE5 with motor control for 1 x 230 V or 3 x 400 V connection. The motor control and the motor are protected from overloading, blocking, over and under voltage, and over heating.

The motor control is factory programmed by EXHAUSTO for optimal operation of the fan. It only requires mains connection and a control signal from an EXHAUSTO EFC1P2 or MAC12 controller or a 0-10V signal.

The motor controls also provide a Modbus interface for fan control and alarm read-offs etc.

## Curve

