

# 1 NON FIRE-RATED EXHAUST BOX FANS

Ventilation box fan

## BESF28043EC

### BESF280EC

Box fan in 7 sizes – most can be selected with EC motor. Compact box fan targeted need for fast flow changes.



### PRODUCT BENEFITS

- Compact
- Fast flow changes
- Reliable solution
- F wheels (forward curved blades)

### Product description

#### DESCRIPTION

The BESF box fan is a fan with forward-curved F impeller and sound-damping insulation. BESF is available in 7 sizes: BESF146, -160, -180, -200, -225, -250, and -280.

For most sizes, a model with EC motor can be selected for more efficient operation. Get an overview of the individual sizes below.

#### TEMPERATURE

In normal operation, tolerates temperatures up to 60 °C.

#### Combustion-gas fan

If there is a need for a certified combustion gas fan, we draw your attention to the FSB box fan, described under the product group Fire Protection

### Accessories

Description	Variants
FLF315-Ø315, flex connection	FLF315
MAC12 constant pressure regulator	MAC12
EFC1P2, Electronical speed regulator	EFC1P2

### Fan data

Max. Total efficiency (A-D) (%)	58,5
Ventilation energy class - Average climate	D
Efficiency level requirements	49, N (2015)
ECO efficiency level during optimal operating point	73,2
EC motor	EC motor with integral VSD
Nominal speed (RPM)	1448
Power supply	3x400 V
Overload protection	Integrated in motor control
Engine power (kW)	2,2

## Ventilation box fan

**BESF28043EC****BESF280EC**

## Dimensional data

A (mm)	600
B (mm)	515
C (mm)	360
G (mm)	650
E Ø (mm)	315
Weight (kg)	65

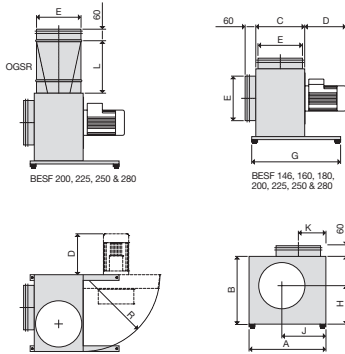

The BESF box fan can be mounted in various positions. Note, however, that the ventilator must not be positioned with the motor turned downwards.

Standard installation: A

Alternative installation options B/C/D:

NB:

During intermittent operation, there is a risk of condensation in the motor – use mounting method A or B  
The BESF box fan must not be installed outdoors – here we refer to the outdoor version of the BESB (OD).

## Airflow data

Max. airflow (m <sup>3</sup> /h)	5080
----------------------------------	------

## Electrical datas

Voltage (V)	3x400
Frequency (Hz)	50
Max. current (A)	5,3
Engine power (kW)	2,2
ErP-effektivitetsgrad i optimalt driftspunkt	71

## Regulatory data

Ventilation energy class - Average climate	D
--	---

Ventilation box fan

**BESF28043EC**  
**BESF280EC**

Installation

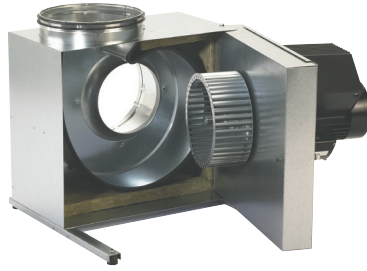
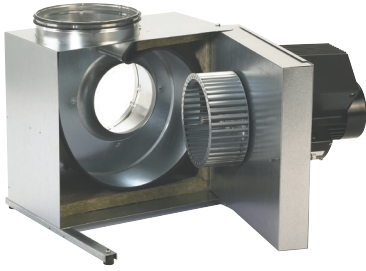

BESF box fans are made from Aluzinc® AZ185 class C4 in accordance with EN/ISO12944-2 and sound and condensation-insulated with 30 mm mineral wool.

As standard, BESF can handle gas temperatures up to 60°C.

When used as a smoke extract fan:  
BESF146-180 can as standard withstand up to 200°C for 60 min.  
As standard, BESF200-280 can handle up to 300°C for 60 min.

If certified fire gas fan is to be used, we refer to the FSB fan

The fan impeller is an F-impeller made from galvanised steel.

It has forward-curved blades, which means that the box fan is able to generate a high pressure for its compact size.

The spigots on BESF have rubber gaskets to ease mounting of ducts.

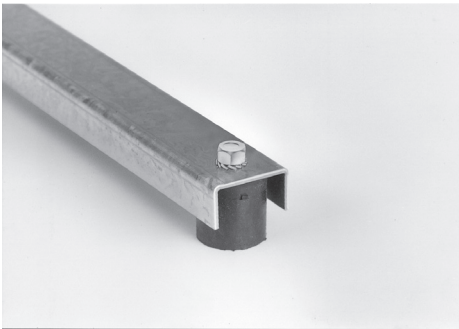

To minimise noise and vibration, the box fan is fitted as standard with efficient vibration dampers mounted on brackets.

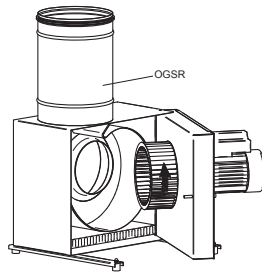

To minimise system pressure drop when connecting to a duct system, we recommend the use of an OGSR transition piece (accessory).

OGSR is a specially developed circular transition piece with integral guide panels; it can be supplied for BESF200, 225, 250 and 280 and allows maximum capacity and efficiency to be achieved.

OGSR is not available with other BESF models.

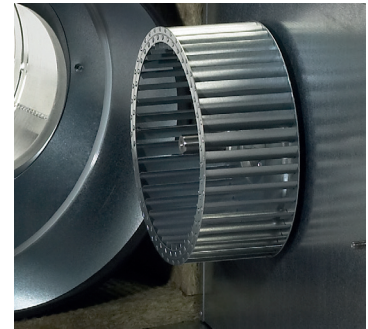

BESF box ventilators have their motor connected directly to the ventilator impeller.

BESF box fans are available with four types of motor:  
> EC-motor  
> Single-phase AC motor

The motors are made to protection class IP54 and all materials are as a minimum class F (155 °C). All motor types have integral current overload protection.

Curve

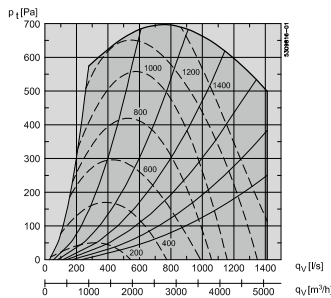

As standard, BESF can handle gas temperatures up to 60°C.