

CMEV air handling unit

## A11059078

### DEX3120 - surface-mounted

The environmentally friendly, quiet and most effective ventilation solution for schools – equipped with counterflow heat exchanger



#### PRODUCT BENEFITS

- Excellent sound-absorbing insulation that ensures a quiet learning environment,
- Easy and simple installation – service and maintenance can be carried out by one person,
- Best indoor air quality due to site-specific filtration offer,

#### Principles of operation

DEX3000 brings fresh, filtered air into the building and recovers heat from the exhaust air by means of its highly efficient heat exchanger. The supply air can be heated and/or cooled with a complete range of accessories such as heating/cooling coils.

#### Product description

A decentralised air handling unit is a simple solution where one air handling unit is placed in each room with separate connection through a wall or ceiling/roof. The simple installation means no need to fit ventilation ducts and other air distribution systems. The DEX3000 units can be installed on an ongoing basis in line with needs and finances, and installation can take place room by room, section by section, without affecting the school's normal operations.

#### Installation

- Indoors: in a class room, office environment or similar
- Ceiling-mounted installation (visible or semi-integrated free or against a wall)
- Limited need for duct mounting

#### Main characteristics

- 3 decentral models: 600 m<sup>3</sup>/h, 900 m<sup>3</sup>/h and 1400 m<sup>3</sup>/h, in 2 versions free-hanging or semi-integrated:
  - Visible versions (STD)
  - Semi-integrated (INT) for installation under suspended ceiling
- Monoblock design
- Insulation – 50-mm insulation material for lowest sound or noise level, Basotect (M1 fire class), Puresound (VDI 6022)
- Exterior finish: Aluzinc AZ185: corrosion class C4. Decor panels pre-coated material in white (standard)
- Horizontal mounting with wall bracket option
- EC motor with F impeller fan
- High-performance counter flow heating exchanger (Eurovent AAHE)
- Modulating bypass
- ePM10 60% (M5) and ePM1 55% (F7). Pre-filter coarse 60% (G4), as accessory/option
- Accessories/option:
  - Integrated CO<sub>2</sub> sensor
  - Integrated motion sensor - PIR
  - Integrated humidity sensor - %HR
  - Webserver communication - WEBE
  - HMI interface (for start and setting)
  - When both integrated CO<sub>2</sub> sensor and integrated PIR are selected, the unit will be fully plug and play

## CMEV air handling unit

**A11059078****DEX3120 - surface-mounted****Supplementary characteristics**

- EXcon Control System:
  - Constant speed,
  - Constant airflow,
  - Constant pressure,
  - Air measurement control CO<sub>2</sub>/VOC sensor (0–10V signal),
  - Controlled pressure,
  - Built-in clock: operation hours can be controlled by means of a timer,
  - Remote control system via cable,
  - BMS Communication via Modbus RTU and Bacnet TCP/IP protocols,
  - Constant air speed (CAV),
  - Variable air speed (VAV),
  - Airflow controlled - demand controlled (DCV) using CO<sub>2</sub>/VOC sensor (0–10V signal),
  - Option: Built-in web server,
  - Option: BMS communication via Modbus RTU/RS485, Modbus TCP/IP, BACnet, MSTP/BACnet IP.

**Accessories**

Description	Variants
CONPUMP	#CONPUMP
CO2B	#CO2B
HMI panel for EXcon	HMI1TOUCH
Closing damper with spring-return Ø 400 mm	LSR40024
YGC Ø315 External wall grille ACCESSORIES_EXHAUSTO00-4 ACCESSORIES_EXHAUSTO00-4 ACCESSORIES_EXHAUSTO00-5	YGC400ALU
Fire Thermostat	BT40-70

**Filters**

Description	Variants
Panel filter for DEX3120 - Coarse 85%	FPD3120C85

**General data**

Motor class in accordance with IEC TS 60034-30-2	IE5 (Ultra Premium Efficiency)
--	--------------------------------

CMEV air handling unit

## A11059078

DEX3120 - surface-mounted

### Dimensional data

A (mm)	2406
B (mm)	600
C (mm)	1463
D (mm)	1957
E (mm)	123
F (mm)	633
G (mm)	627
H (mm)	80
I (mm)	400
J (mm)	308
K (mm)	290
L (mm)	273
M (mm)	290
N (mm)	1825
O (mm)	296
P (mm)	308
Q (mm)	296
R (mm)	273
S (mm)	1825
T (mm)	345
U (mm)	290
Ø connection (mm)	400
Weight (kg)	300

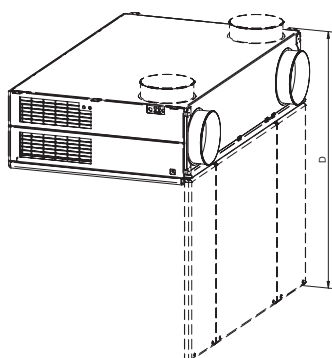

RD14289-04

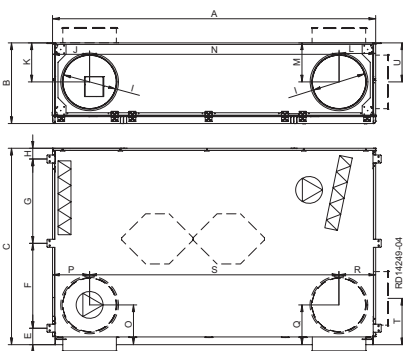

### Airflow data

Minimum airflow	300
Max. airflow ErP (m³/h)	1455
Max. airflow (m³/h)	1455

### Heat recovery data

Max. exchanger output (%)	90
---------------------------	----

### Electrical datas

Voltage (V)	1x230
Frequency (Hz)	50
Electrical coil voltage 1	3x400
Voltage of electrical coil 2	3x400
Max. power of electrical coil 1 (kW)	3,6
Max. power of electrical coil 2	9,0
Maximum current - unit (A)	4,9
Maximum current - first coil (A)	4,3
Maximum current - second coil (A)	8,8
Max. electrical output of unit (kW)	1,1

CMEV air handling unit

**A11059078**

DEX3120 - surface-mounted

CMEV air handling unit

**A11059078**

**DEX3120 - surface-mounted**

**Installation**

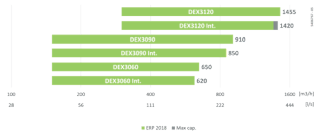

**EXAMPLES OF USAGE**

Learn better in fresh oxygen-saturated air  
When the air in the classroom is clean, students keep their heads clear and get more out of their lessons. Fresh, oxygen-saturated air boosts concentration, success and happiness. The DEX3000 series is designed to help children and teachers feel comfortable in any classroom. Air quality is really important in classrooms.

During the pandemic, we realised the value of clean air without invisible microorganisms. By constantly exchanging the air, the spread of viruses and bacteria is reduced. This reduces the risk of teachers and students infecting each other.



Perform better at work with oxygen for the brain  
At work, many people spend time together in a relatively limited space – often for many hours at a time. A decentralised air handling unit from the DEX3000 series keeps the air constantly fresh, both in the office and in the meeting room. This results in increased attention and performance. Whether you're in a small meeting room or a large conference room, we have a system that cleans the air continuously. Completely silent, of course, so you don't have to raise your voice.

Exercise in fresh air – indoors  
When the air in the gym is shared by many hard-working bodies, the air quality drops as weights are lifted. This can be particularly bad in training areas with treadmills, rowing machines and handweights. Here, the air can be so low on oxygen that you can question the effect of the training. With DEX3000 ventilation units, the training experience becomes almost like playing sports outdoors. So welcome to the outdoors - indoors. The technology is easy to install and requires minimal maintenance.

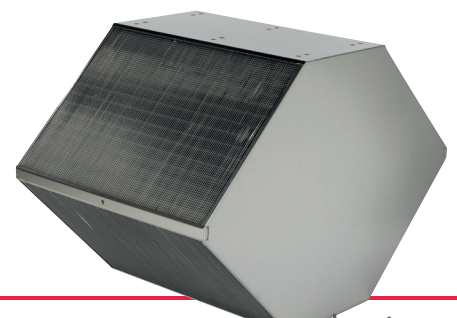

## CMEV air handling unit

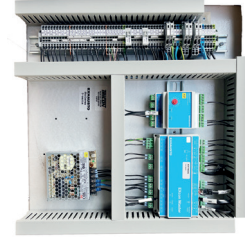
**A11059078****DEX3120 - surface-mounted**

DEX3000 is equipped with compact filters in the two airflows – the filters are easy to replace.

The following filters are used as standard:

Extract air filter ePM10 60% (M5)  
Supply air: ePM1 55% (F7).  
ePM1 80% (F9) is available as an added option.

In order to achieve a longer service life for the advanced filters in particular, it is also possible to fit a pre-filter, filter type ISO Coarse 85% (G4) Compact filter.

The units can be supplied with or without built-in cooling/heating coil. Choose between electric heating coil, water heating coil, cooling coil or change-over coil.

The connection box can be accessed on the right side of the unit. When the door is open, the operator section can be pulled down for easier access.

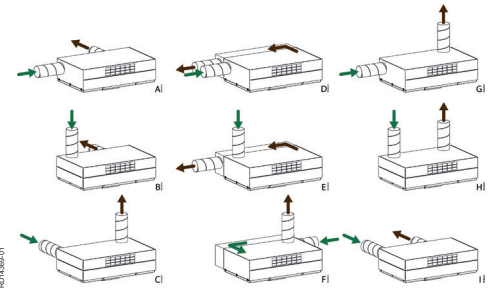
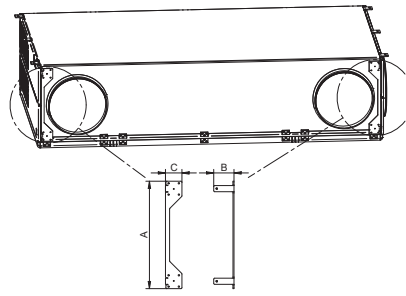
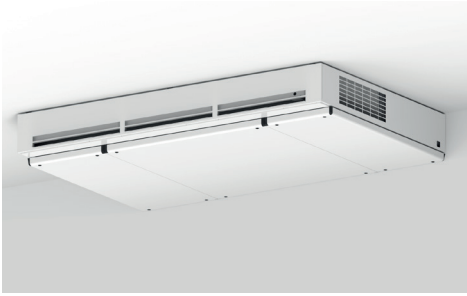
**SEMI-INTEGRATED FITTING**

DEX3000 can also be ordered in a design intended for semi-integrated fitting in a suspended ceiling. In this way, a large part of the air handling unit is hidden in the suspended ceiling, while the bottom part from which the supply air exits will be visible. This results in a discreet and compact installation that does not significantly reduce the ceiling height.

**FITTING**

The unit is attached to the ceiling structure with the mounting brackets provided. It is important to pay attention to whether the load-bearing capacity of the ceiling structure is sufficient to carry the unit; find the unit's weight in the technical data. For detailed instructions, please refer to the installation instructions.

If the outdoor air and exhaust air go directly backwards through the wall, we recommend using the two transport brackets for extra fastening – see the drawing below.

**INSTALLATION OPTIONS**

In the individual room, there will often be one optimal location for the unit. It is therefore a great advantage that DEX3000 offers multiple options for connection to duct systems. The unit can be connected with the ducts led backwards through the wall, led up through the ceiling or out from the side towards the outer wall – see illustration below.

CMEV air handling unit

**A11059078**

**DEX3120 - surface-mounted**



**HIGHER EFFICIENCY**

In order to distribute the fresh air optimally in the room, the DEX3000 series units use the so-called "Coanda effect": When the unit is mounted directly under the ceiling, a negative pressure is created between the air flow from the unit (supply air) and the ceiling surface, and the supply air flow is kept close to the ceiling. The supply air is mixed with room air during the entire process, which reduces the air speed and ensures a fast and efficient distribution of the fresh air throughout the room. In order for this principle to work, no large obstacles such as lamp cassettes etc. may be placed in the ceiling.

Other factors that affect good ventilation efficiency and air distribution:

Positioning of the device directly under the ceiling for correct exit angle and utilisation of the coanda effect  
 Temperature ratio between room air and supply air  
 Energy from blow-in jet (air roller)  
 The illustrations below show the different throw lengths at corresponding air volumes.

The goal is to have a constant air speed (L02) of < 0.2 m/s in the living area to avoid draughts.

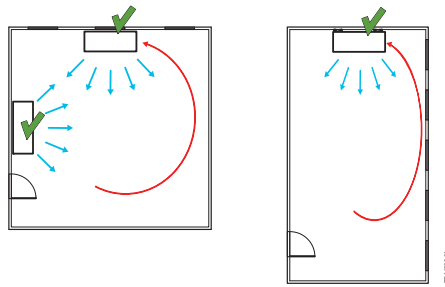

**Positioning of DEX3000**

When planning a DEX3000 solution, the shape of the room is taken into consideration to achieve the optimal positioning of the unit.

In rooms with a square ground plan with walls that are almost equal in length, the DEX3000 can be freely positioned, as close as possible to the middle of a wall. In narrow rooms, we recommend that DEX3000 is placed in the middle of the short wall to ensure good circulation of the ventilation air; placement on the long wall should be avoided.

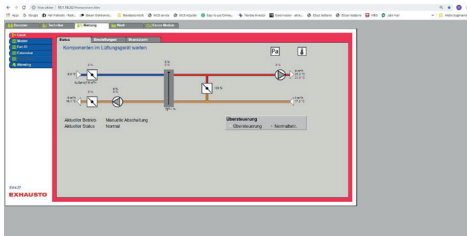

**Web sever monitoring**

DEX3000 is supplied with EXcon-control system including a web server solution, where several units can be monitored from a central location, e.g. the caretaker's office.

This means you can have a full overview of the units' operation. At the same time, the web server solution provides additional control options.

As an accessory to the DEX3000, a loose HMI-panel can be ordered and connected to the DEX3000 with a service cable. The HMI control panel allows unit operation to be monitored and further adjustments can be made. One control panel can be used for several DEX3000 units.

The control panel is simple and convenient for all types of user, thanks to its visual control system.

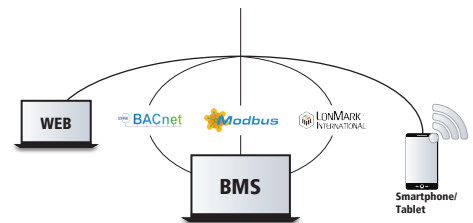

**EXCON CONTROL SYSTEM**

What are the features of the integrated EXcon control system

User-friendly

> Integral intelligent web server with information level adaptable to user

Reliable

- > The modular BUS system eliminates potential errors
- > Security from unauthorised access
- > Effective troubleshooting and monitoring

Optimum costs

- > Simple implementation, training and maintenance
- > Multiple adjustment options
- > Uniquely user-friendly
- > Energy savings through optimum operation

Flexible

- > A customisable platform
- > Possible upgrade

Future-proof

- > Adaptations via SD card
- > Option to integrate into multiple CTS systems

CMEV air handling unit

**A11059078**

DEX3120 - surface-mounted