

1 ROOF DUCTS

Accessory for plastic ventilation ductwork

THA160

THA160, roof terminal exhaust

Roof terminal for air exhaust in connection with mechanical ventilation system.



PRODUCT BENEFITS

- Simple design
- Easy fitting
- Multiple sizes available

Product description

EXHAUSTO roof terminal THA is designed for air exhaust and THF is designed for outdoor air intake in connection with mechanical ventilation systems.

The construction of the roof terminal ensures a good air technical solution with minimal pressure drop.

Note: THA/THF does not comply with Fire Code DS428, which requires 50 mm insulation in roof penetrations.

Dimensional data

C2	280
L1 - 0-35	707
L1 - 36-60	892
Ø C (mm)	160
Height (mm)	160
Empty weight (kg)	5

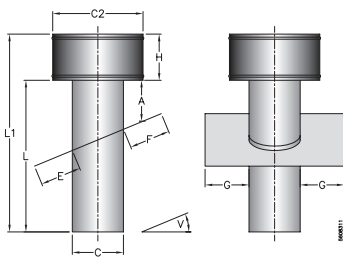

Accessory for plastic ventilation ductwork

THA160

THA160, roof terminal exhaust

Installation

Dimensions E, F and G apply only to PERFORM flashing.
With zinc, the flashing is always 100 mm.

PERFORM flashing can cater for +/- 2.5° relative to the given roof pitch.

A dimension varies according to degree dimension. C = adapter size.

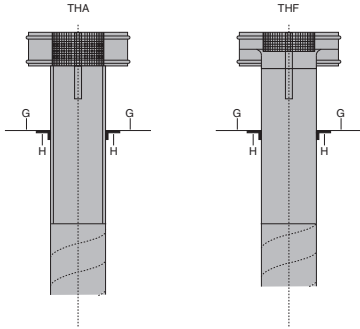

The THA roof terminal is for exhaust air. The large free space ensures a low pressure drop, even where air volumes are large. It has an integral bird protection net

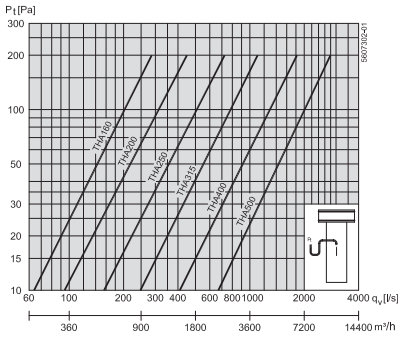

Dimensions E, F and G apply only to PERFORM flashing.
With zinc, the flashing is always 100 mm

PERFORM flashing can cater for +/- 2.5° relative to the given roof pitch.

A dimension varies according to degree dimension. C = adapter size.

Curve

