

1 ROOF DUCTS

Accessory for plastic ventilation ductwork

THF250

THF250, roof terminal exhaust

Roof terminal for air intake in connection with mechanical ventilation system.



PRODUCT BENEFITS

- Simple design
- Easy fitting
- Multiple sizes available

Product description

EXHAUSTO roof terminal THA is designed for air exhaust and THF is designed for outdoor air intake in connection with mechanical ventilation systems.

The construction of the roof terminals ensures a good air technical solution with minimal pressure drop.

Note: THA/THF does not comply with the Fire Standard DS428, which requires 50 mm insulation in roof penetration.

Dimensional data

C (mm)	250
C2	440
H (mm)	190
L1 - 0-35	894
L1 - 36-60	1169
Empty weight (kg)	9

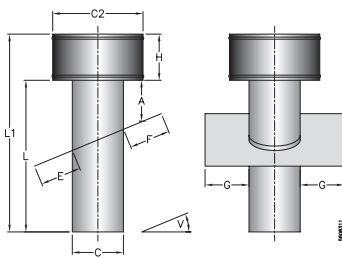

Accessory for plastic ventilation ductwork

THF250**THF250, roof terminal exhaust****Installation**

Dimensions E, F and G apply only to PERFORM flashing.
With zinc, the flashing is always 100 mm.

PERFORM flashing can cater for $\pm 2.5^\circ$ relative to the given roof pitch.

A dimension varies according to degree dimension. C = adapter size.

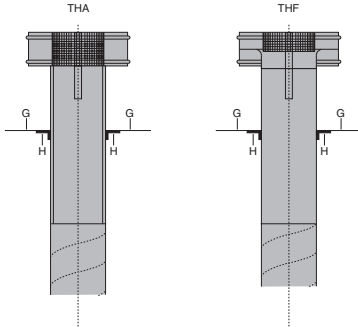

The THF roof terminal is for outdoor air intakes with a round inlet, giving minimal pressure drop. It has an integral bird net.

Dimensions E, F and G apply only to PERFORM flashing.
With zinc, the flashing is always 100 mm

PERFORM flashing can cater for $\pm 2.5^\circ$ relative to the given roof pitch.

A dimension varies according to degree dimension. C = adapter size.

Curve