

1 ROOF DUCTS

Roof terminal

THFV200-1200

THFV200-1200, roof terminal for outdoor air intake

Roof terminal for vertical air intake – used as end of the duct system above the roof. Attractive design, easy installation and low-noise design



PRODUCT BENEFITS

- Modern design
- Easy fitting
- Low-noise design

Product description

EXHAUSTO roof terminal THFV is for outdoor air intakes.

The roof terminals are for use where an architecturally attractive and technically sound roof termination is required for duct systems. The roof terminals are easy to mount on different roofing constructions.

The low-noise design makes them particularly suitable for built-up areas with high environmental requirements.

Fields of application

New, Refurbishment, Non-residential buildings, Schools

Dimensional data

C1	200
L (mm)	1200
L1 (mm)	1385
Ø C (mm)	305
Empty weight (kg)	17
Max. Dachneigung V (°)	60

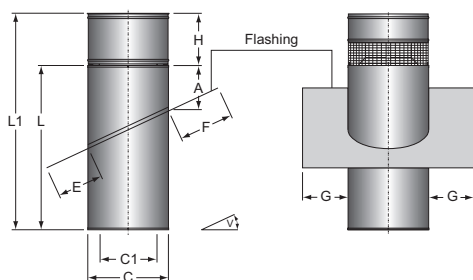

Roof terminal

THFV200-1200

THFV200-1200, roof terminal for outdoor air intake

Installation

Dimensions E, F and G apply only to PERFORM flashing.
With zinc, the flashing is always 100 mm.

PERFORM flashing can cater for +/- 2.5° relative to the given roof pitch.

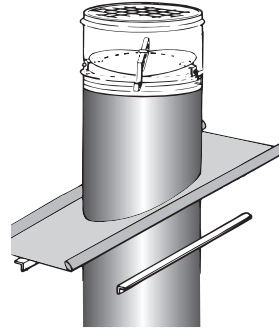
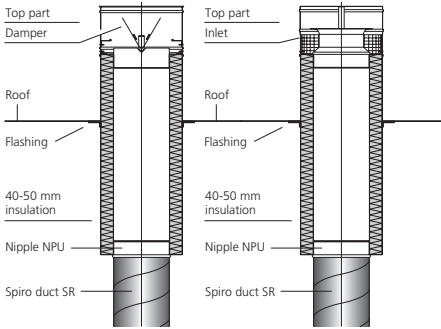

THFV roof terminals are for outdoor air intakes with a round inlet, giving minimal pressure drop. THFV has an integrated bird net.

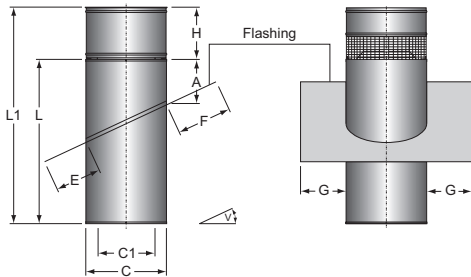
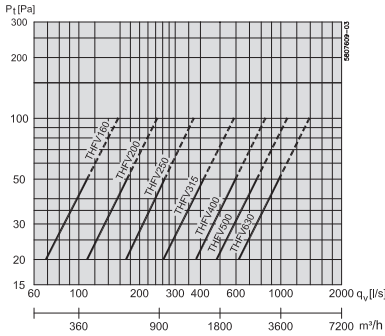

Dimensions E, F and G apply only to PERFORM flashing.
With zinc, the flashing is always 100 mm

PERFORM flashing can cater for +/- 2.5° relative to the given roof pitch.

Roof terminal

THFV200-1200

THFV200-1200, roof terminal for outdoor air intake

Curve

